



VALIDATION SUMMARY REPORT

Walk-in Refrigeration Storage / Cold Room

Title: Validation Summary Report for Walk-in Refrigeration / Cold Room Model DT810

Manufacturer:	Polar King International, Inc.
Model Number:	DT810
Equipment ID / Serial No:	917-7717

Revision Number: 1
Issue Date: 01/24/2018



Manufacturer:	Polar King International, Inc.
Model Number:	DT810
Equipment ID / Serial No:	916-7717

Table Of Contents

1.0	INTRODUCTION	3
2.0	REFERENCES	3
3.0	SUMMARY	3
3.1	INSTALLATION & QUALIFICATION	3
3.1.1	System Components Identification	3
3.1.2	Documentation Verification	3
3.1.3	Refrigeration System Components Visual Inspection.....	3
3.1.4	Electrical Supply Verification	3
3.1.5	Thermostatic Controller Identification	4
3.1.6	Refrigeration System Spare Parts	4
3.2	OPERATION QUALIFICATION.....	4
3.2.1	Vaisala Validation Equipment Calibration Verification	4
3.2.2	Temperature Data Logger Placement.....	4
3.2.3	24-HR Empty Unit Thermal Mapping (5°C Set Point)	5
3.2.4	Empty Unit Open Door Temperature Recovery (5°C Set Point).....	6
3.2.5	Empty Unit Power Failure Test (5°C Set Point)	7
3.2.6	24-HR Empty Unit Thermal Mapping (-20°C Set Point).....	7
3.2.7	Empty Unit Open Door Temperature Recovery (-20°C Set Point).....	8
3.2.8	Empty Unit Power Failure Test (-20°C Set Point)	8
3.3	Qualification Deviations	8
4.0	CONCLUSION	8
5.0	APPROVALS	9
6.0	Vaisala DL1000-1400 Specifications	10
7.0	Polar Leasing 8x10 Dual Temperature Unit Line Drawing	14



Title: Validation Summary Report for Walk-in Refrigeration / Cold Room Model DT810

Manufacturer:	Polar King International, Inc.
Model Number:	DT810
Equipment ID / Serial No:	916-7717

1.0 INTRODUCTION

The Validation Summary Report summarizes the qualification activities measured on the Walk-In Cold Room, Polar Leasing Unit #916-7717. The unit is manufactured by Polar King International, Inc. and has a model number of DT-810. It is controlled by a Johnson Controls thermostat model A419. This summary also covers any discrepancies encountered throughout the validation study.

2.0 REFERENCES

Temperature mapping of storage area, technical supplement to WHO Technical Report Series, No. 961, 2011.

3.0 SUMMARY

3.1 INSTALLATION & QULAIFICATION

The validation study for #916-7717 was completed on January 18th, 2018. Verifications for the study were documented and saved using Vaisala Veriteq vLog.

3.1.1 System Components Identification

Identification information for the Cold Room was verified. This included model and serial numbers for the condensing unit, compressor, and structure. Refrigerant type and expansion valve were confirmed, as was insulation thickness.

3.1.2 Documentation Verification

Documentation for installation and maintenance of #916-7717 was obtained. These documents were reviewed, and include manuals, CAD drawings, quality control reports and production worksheets.

3.1.3 Refrigeration System Components Visual Inspection

A visual inspection of refrigeration system components was conducted to verify the equipment was installed in accordance with the manufacturer's recommendation. Critical components were confirmed to be in new working order. No damage was noted.

3.1.4 Electrical Supply Verification

A Fluke Multimeter was used to confirm the provided voltage supply was in accordance with requirements specified on the serial plate of the Cold Room.



Manufacturer:	Polar King International, Inc.
Model Number:	DT810
Equipment ID / Serial No:	916-7717

3.1.5 Thermostatic Controller Identification

The installation location of the thermostatic control was noted and documented as required. All set points used for testing were documented as necessary.

3.1.6 Refrigeration System Spare Parts

No spare parts are required for the Validation Summary.

3.2 OPERATION QUALIFICATIONS

3.2.1 Vaisala Validation Equipment Calibration Verification

Calibration documentation for (19) Vaisala DL1000-1400 was reviewed and all temperature data loggers were found to be in calibration as required.

3.2.2 Temperature Data Logger Placement

The set-up of all temperature monitoring loggers was done in accordance with acceptable usage practices, obtaining measurements at multiple low, medium and high points within the Cold Room. A total of 19 data points were logged in each study, as shown in Figure 1.

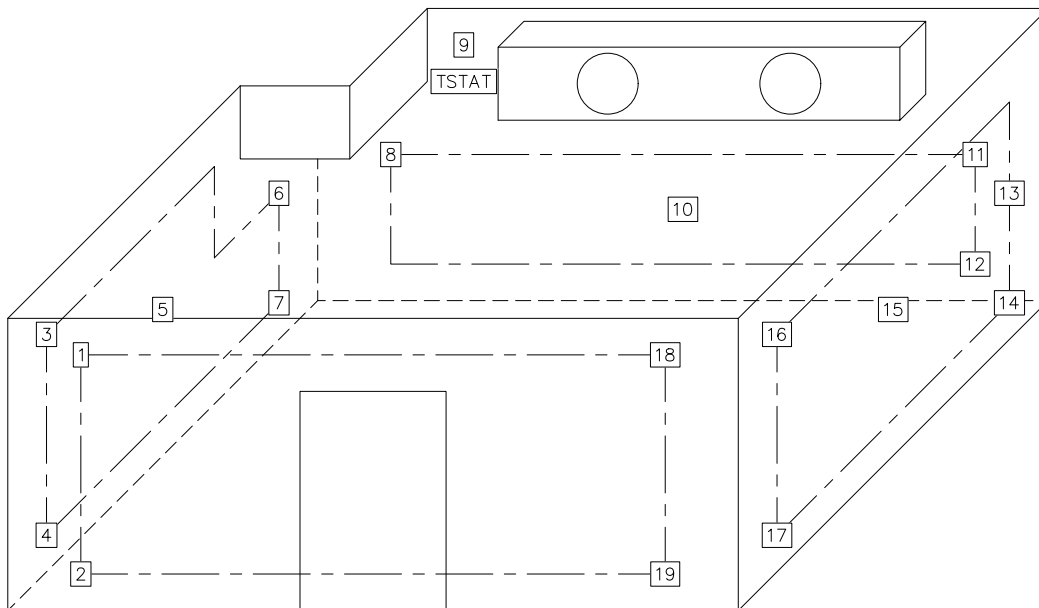

Figure 1



Manufacturer:	Polar King International, Inc.
Model Number:	DT810
Equipment ID / Serial No:	916-7717

Table 1: Temperature Data Logger Locations and Labels

Data Logger Location	Data Logger Label	Alternate Data Logger Label
1	VA Logger #1	17341013
2	VA Logger #2	17341014
3	VA Logger #3	17381125
4	VA Logger #4	17381130
5	VA Logger #5	17381127
6	VA Logger #6	17381085
7	VA Logger #7	17381084
8	VA Logger #8	17381124
9	VA Logger #9	17381128
10	VA Logger #10	17381126
11	VA Logger #11	17381086
12	VA Logger #12	17381082
13	VA Logger #13	17371094
14	VA Logger #14	17381121
15	VA Logger #15	17381122
16	VA Logger #16	16451060
17	VA Logger #17	17381123
18	VA Logger #18	17371120
19	VA Logger #19	17371109

3.2.3 24-HR Empty Unit Thermal Mapping (5°C Set Point)

At a set point of 5°C the Cold Room was tested empty, with the door closed. Temperature data loggers were positioned as shown in Figure 1. Temperature data was recorded for a 24 hour period, from 04:00pm EDT on 12/18/17 to 04:00pm EDT on 12/19/17. The data was logged at 2 minute intervals. Individual graph and data reports, as well as a summary data report have been included as appendices. The summarized data for all 19 temperature data loggers can be found in Table 2.



Manufacturer:	Polar King International, Inc.
Model Number:	DT810
Equipment ID / Serial No:	916-7717

Table 2: Temperature Data Logger Locations and Labels

Data Logger Location	Data Logger Label	Data Logger Label (Alternate)	Max Temp (°C)	Avg. Temp (°C)	Min Temp (°C)
1	VA Logger #1	17341013	6.78	5.76	4.55
2	VA Logger #2	17341014	6.50	5.66	4.48
3	VA Logger #3	17381125	6.82	5.50	4.08
4	VA Logger #4	17381130	6.75	5.56	3.47
5	VA Logger #5	17381127	6.44	5.53	4.28
6	VA Logger #6	17381085	6.46	5.47	4.28
7	VA Logger #7	17381084	6.42	5.52	4.30
8	VA Logger #8	17381124	6.40	5.50	4.42
9	VA Logger #9	17381128	7.72	5.68	4.18
10	VA Logger #10	17381126	6.72	5.34	2.45
11	VA Logger #11	17381086	6.65	5.36	3.13
12	VA Logger #12	17381082	6.55	5.32	3.36
13	VA Logger #13	17371094	6.49	5.40	3.75
14	VA Logger #14	17381121	6.41	5.39	4.08
15	VA Logger #15	17381122	6.51	5.38	3.56
16	VA Logger #16	16451060	6.62	5.28	3.05
17	VA Logger #17	17381123	6.42	5.33	3.94
18	VA Logger #18	17371120	6.71	5.27	3.26
19	VA Logger #19	17371109	6.63	5.44	3.59

3.2.4 Empty Unit Open Door Temperature Recovery (5°C Set Point)

The test was conducted between 11:12am EDT and 12:02pm EDT on 01/18/18. Temperature was logged at 30 second intervals. After 25 minutes, no temperatures outside of the specification were recorded. The test was terminated after 25 minutes, as door openings of this length are well outside of the scope of use. The graphical and detailed report of internal and external data loggers is appended.



Manufacturer:	Polar King International, Inc.
Model Number:	DT810
Equipment ID / Serial No:	916-7717

3.2.5 Empty Unit Power Failure Test (5°C Set Point)

The test was conducted between 02:21pm EDT and 5:00pm EDT on 01/17/18. Temperature was logged at 30 second intervals. The logged data showed the empty Cold Room, with the power supply disconnected; the unit held temperature within the acceptable range for 1 hour and 15 minutes. With restored power, the unit stabilized within the acceptable range in approximately 3 minutes. The graphical report and data logs are appended.

3.2.6 24-HR Empty Unit Thermal Mapping (-20°C Set Point)

At a set point of -20°C the Cold Room was tested empty, with the door closed. Temperature data loggers were positioned as shown in figure 1. Temperature data was recorded for a 24 hour period, from 04:00pm EDT on 01/10/18 to 04:00pm EDT on 01/11/18. The data was logged at 30 second intervals. Individual graph and data reports, as well as a summary data report have been included as appendices. The summarized data for all 19 temperature data loggers can be found in Table 3. No deviations were recorded during testing.

Data Logger Location	Data Logger Label	Alternate Data Logger Label	Max Temp (°C)	Avg. Temp (°C)	Min Temp (°C)
1	VA Logger #1	17341013	-12.52	-18.79	-19.98
2	VA Logger #2	17341014	-15.48	-19.15	-19.95
3	VA Logger #3	17381125	-12.55	-19.30	-20.48
4	VA Logger #4	17381130	-14.20	-19.44	-20.92
5	VA Logger #5	17381127	-14.88	-19.36	-20.84
6	VA Logger #6	17381085	-15.20	-19.41	-20.43
7	VA Logger #7	17381084	-15.32	-19.31	-20.13
8	VA Logger #8	17381124	-14.56	-19.41	-20.34
9	VA Logger #9	17381128	-11.47	-19.11	-20.32
10	VA Logger #10	17381126	-12.22	-19.76	-21.70
11	VA Logger #11	17381086	-12.93	-19.63	-21.16
12	VA Logger #12	17381082	-14.36	-19.71	-21.17
13	VA Logger #13	17371094	-13.97	-19.59	-20.64
14	VA Logger #14	17381121	-15.26	-19.52	-20.42
15	VA Logger #15	17381122	-13.68	-19.66	-21.18
16	VA Logger #16	16451060	-11.71	-19.96	-22.00
17	VA Logger #17	17381123	-15.06	-19.72	-20.70
18	VA Logger #18	17371120	-12.89	-19.86	-21.38
19	VA Logger #19	17371109	-13.91	-19.48	-20.87



Title: Validation Summary Report for Walk-in Refrigeration / Cold Room Model DT810

Manufacturer:	Polar King International, Inc.
Model Number:	DT810
Equipment ID / Serial No:	916-7717

3.2.7 Empty Unit Open Door Temperature Recovery (-20°C Set Point)

The test was conducted between 12:05pm EDT and 01:05pm EDT on 01/09/18. After 25 minutes, only one temperature data logger showed temperatures outside of specification, while test criteria required at least 50% of data loggers to do so. The test was terminated after 25 minutes, as door openings of this length are well outside of the scope of use. The graphical and detailed report of internal and external data loggers is appended.

3.2.8 Empty Unit Power Failure Test (-20°C Set Point)

The test was conducted between 08:45am EDT and 12:45pm EST on 01/10/18. Temperature was logged at 30 second intervals. The logged data showed the empty Cold Room, with the power supply disconnected; the unit held temperature within the acceptable range for approximately 2 hours and 20 minutes. With restored power, the unit stabilized within the acceptable range in approximately 5 minutes. The graphical report and data logs are appended.

3.3 Qualification Deviations

No deviations were found during testing.

4.0 CONCLUSION

Temperature validation of #916-7717 was deemed successful, without any noted deviations.



Title: Validation Summary Report for Walk-in Refrigeration / Cold Room Model DT810

Manufacturer:	Polar King International, Inc.
Model Number:	DT810
Equipment ID / Serial No:	916-7717

5.0 Approvals

In review of the collected data for this Validation Summary Report, this study has been deemed successfully completed with satisfactory results. All deviations are listed within the Validation Summary report and are available by request as appendices. The Polar Leasing unit #916-7717 has been successfully validated.

Name: David C. Schenkel Signature: [Handwritten Signature]

Title: President Date: 1/24/18

Name: Todd Ellinger Signature: [Handwritten Signature]

Title: VP Business Admin Date: 1-24-18

Polar Leasing Company Approvals:

The signatures below indicate a full review and understanding of the validation data, thus fully completing the requirements of the report.

Name: Bert Tippmann Signature: [Handwritten Signature]

Title: President Date: 1-24-18

Name: _____ Signature: _____

Title: _____ Date: _____

Manufacturer:	Polar King International, Inc.
Model Number:	DT810
Equipment ID / Serial No:	916-7717



Vaisala DL1000-1400 Temperature Data Logger



The 1000/1400 temperature data loggers include the VL-series for regulated environments and the SP-series for non FDA/GxP regulated industries. The VL-series of data loggers, together with vLog VL software, provide a superior, high accuracy solution for use in FDA/GxP regulated environments by ensuring tamperproof files and electronic records that meet 21 CFR Part 11 requirements. The SP-series provides a compact, easily deployable, highly

accurate measurement and recording device. Coupled with vLog SP software for downloading, displaying, analyzing and reporting of recorded environmental data, the SP-series was designed for use in non FDA/GxP regulated environments. Optional browser-based viewLinc software provides 24/7 multi-stage alarm notification and remote monitoring for both the VL and SP series of data loggers.

Features/Benefits

- Industry-leading precision and accuracy
- Printed reports for any time period
- 10-year battery
- Validation and continuous monitoring with the same model
- Two year limited warranty
- Superior alternative to chart recorders and hard-wired systems
- Traceable to SI units through national metrology institutes.*
- Timebase calibrated over the operating temperature range
- Adjustable time based recording
- Snap-in logger cradle for easy network connectivity
- Two probe options give high accuracy - from -90 °C to +70 °C

* Measurement results are traceable to the international system of units (SI) through national metrology institutes (NIST USA, MIKES Finland, or equivalent) or ISO/IEC 17025 accredited calibration laboratories.

Applications

- Ideal for Monitoring & Validation of:
- Refrigerators & Freezers (to -90 °C)
 - Incubators
 - Stability Chambers
 - Warehouses
 - Ambient conditions



Title: Validation Summary Report for Walk-in Refrigeration / Cold Room Model DT810

Manufacturer:	Polar King International, Inc.
Model Number:	DT810
Equipment ID / Serial No:	916-7717

Technical Data

General

Size	85 x 59 x 26 mm (3.4 x 2.3 x 1") 76 g (2.7oz)
Interfaces	RS-232 serial, USB, Ethernet, WiFi, PoE network interface available
Mounting	3M Dual Lock™ Fasteners Snap-in connector locks provide secure probe connections
PC Software	Graphing & Reporting Software vLog SP for SP-series vLog VL for VL-series viewLinc for continuous monitoring & alarming OPC Server to add on to existing OPC compatible monitoring systems
Internal Clock	Accuracy ±1 min. /month -25 °C to +70 °C (-13 °F to +158 °F)
Electromagnetic Compatibility	FCC Part 15 and CE
Power Source	Internal 10-year lithium battery (Battery life specified with sample interval of 1 min. or longer)
Logger Operating/Storage Range	-40 °C to +85 °C (-40 °F to +185 °F) 0 %RH to 100 %RH non-condensing

Internal Temperature Sensor

Series	Sensor Type
1000-21x	Precision-tolerance epoxy-encapsulated NTC thermistor

Memory

Data Sample Capacity	
1000-2XX	48,100 12-bit samples
1400-44X	85,300 12-bit samples
Memory Type	Non-volatile EEPROM
Memory Modes	User selectable: wrap (FIFO) or stop when memory is full. User selectable start time. User selectable stop time (VL series only).
Sampling Rates	User-selectable (in 10 second intervals) from once every 10 seconds to once a day.

Recording Span: 1000-2xx

SAMPLE INTERVAL	NUMBER OF CHANNELS ENABLED	
	1	2
10 Seconds	5.5 Days	2.7 Days
1 Minute	1.1 Months	16.7 Days
5 Minutes	5.5 Months	2.7 Months
15 Minutes	1.3 Years	8.3 Months
1 Hour	5.4 Years	2.7 Years



VL-1000-21x



VL-1000-22x

Recording Span: 1400-44x

SAMPLE INTERVAL	NUMBER OF CHANNELS ENABLED			
	1	2	3	4
10 Seconds	9.8 Days	4.9 Days	3.2 Days	2.4 Days
1 Minute	1.9 Months	29.6 Days	19.7 Days	14.8 Days
5 Minutes	9.8 Months	4.9 Months	3.2 Months	2.4 Months
15 Minutes	2.4 Years	1.2 Years	9.8 Months	7.4 Months
1 Hour	9.7 Years	4.8 Years	3.2 Years	2.4 Years



VL-1400-44x



Manufacturer:	Polar King International, Inc.
Model Number:	DT810
Equipment ID / Serial No:	916-7717

EPT Series Temperature Probes

Sensor Models

"N" Range External Probes	EPT-23N-XXN and EPT-22W-XXN
Operating/Storage Range	-40 °C to +95 °C (-40 °F to +203 °F)
Connector Color Code	Black
"V" Range External Probes	EPT-23N-XXV and EPT-22W-XXV
Operating/Storage Range	-95 °C to +95 °C (-139 °F to +203 °F)
Connector Color Code	Blue

EPT - XXX - XXX

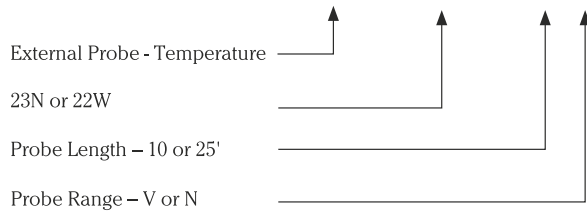

Sensor Tips

EPT-23N-XXX	Stainless Steel Diameter 3.2 mm (1/8") °F Length 38 mm (1.5")
EPT-22W-XXX (liquid submersible)	Sealed Teflon Tip Diameter 3 mm (0.12") Length 28 mm (1.1")
Probe Lengths	3 m (10') and 7.6 m (25')
Cable Construction	2mm (0.07") Diameter Teflon coated cable

Temperature Probe Accessories

Thermal Dampening Block, for use in refrigerators and freezers, simulates a glycol bottle to reduce viewLinc alarms generated by opening and closing a door.





Title: Validation Summary Report for Walk-in Refrigeration / Cold Room Model DT810

Manufacturer:	Polar King International, Inc.
Model Number:	DT810
Equipment ID / Serial No:	916-7717

Product Part Number Legend: Guide for reading the product tables and selecting the most appropriate model for your application.

XX - 1000 - XXX

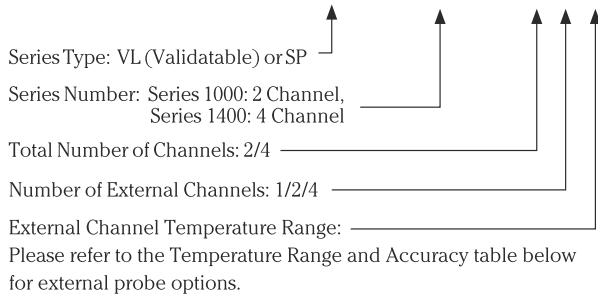

Temperature Range and Accuracy

Internal Sensor

Calibrated	
Measurement Range	-25 °C to +70 °C (-13 °F to +158 °F)
Operating/Storage Range	-40 °C to +85 °C (-40 °F to +185 °F)
0 %RH to 100 %RH non-condensing	
Initial Accuracy	+/-0.10 °C over +20 °C to +30 °C (+/-0.18 °F over +68 °F to +86 °F) +/- 0.2 °C over -25 °C to +70 °C (+/- 0.36 °F over -13 °F to +158 °F)
One Year Accuracy	+/-0.15 °C over +20 °C to +30 °C (+/-0.27 °F over +68 °F to +86 °F) +/-0.25 °C over -25 °C to +70 °C (+/-0.45 °F over -13 °F to +158 °F)
Resolution	0.02 °C at +25 °C (0.04 °F at +77 °F)

External Probes - All Models

"N" RANGE EXTERNAL PROBE	
Calibrated	
Measurement Range	-25 °C to +70 °C (-13 °F to +158 °F)
Operating/Storage Range	-40 °C to +95 °C (-40 °F to +203 °F)
Initial Accuracy*	+/-0.10 °C over +20 °C to +30 °C (+/-0.18 °F over +68 °F to +86 °F) +/-0.15 °C over -25 °C to +70 °C (+/-0.27 °F over -13 °F to +158 °F)
One Year Accuracy*	+/-0.2 °C over +20 °C to +30 °C (+/-0.36 °F over +68 °F to +86 °F) +/-0.25 °C over -25 °C to +70 °C (+/-0.45 °F over -13 °F to +158 °F)
Resolution	0.02 °C at +25 °C (0.04 °F at +77 °F)
"V" RANGE EXTERNAL PROBE	
Calibrated	
Measurement Range	-90 °C to -40 °C (-130 °F to -40 °F)
Operating/Storage Range	-95 °C to +95 °C (-139 °F to +203 °F)
Initial Accuracy*	+/- 0.2 °C over -90 °C to -40 °C (+/- 0.36 °F over -130 °F to -40 °F)
One Year Accuracy*	+/-0.25 °C over -90 °C to -40 °C (+/-0.45 °F over -130 °F to -40 °F)
Resolution	0.02 °C at -80 °C (0.04 °F at -112 °F)

*Specification for external channels is for a probe calibrated to the specific channel of the data logger and with the data logger at -25 °C to +70 °C (-13 °F to +158 °F)



www.vaisala.com

Please contact us at
www.vaisala.com/requestinfo



Scan the code for more information

Ref. B211044EN-D ©Vaisala 2017
This material is subject to copyright protection, with all copyrights retained by Vaisala and its individual partners. All rights reserved. Any logos and/or product names are trademarks of Vaisala or its individual partners. The reproduction, transfer, distribution or storage of information contained in this brochure in any form without the prior written consent of Vaisala is strictly prohibited. All specifications — technical included — are subject to change without notice.





Manufacturer:	Polar King International, Inc.
Model Number:	DT810
Equipment ID / Serial No:	916-7717

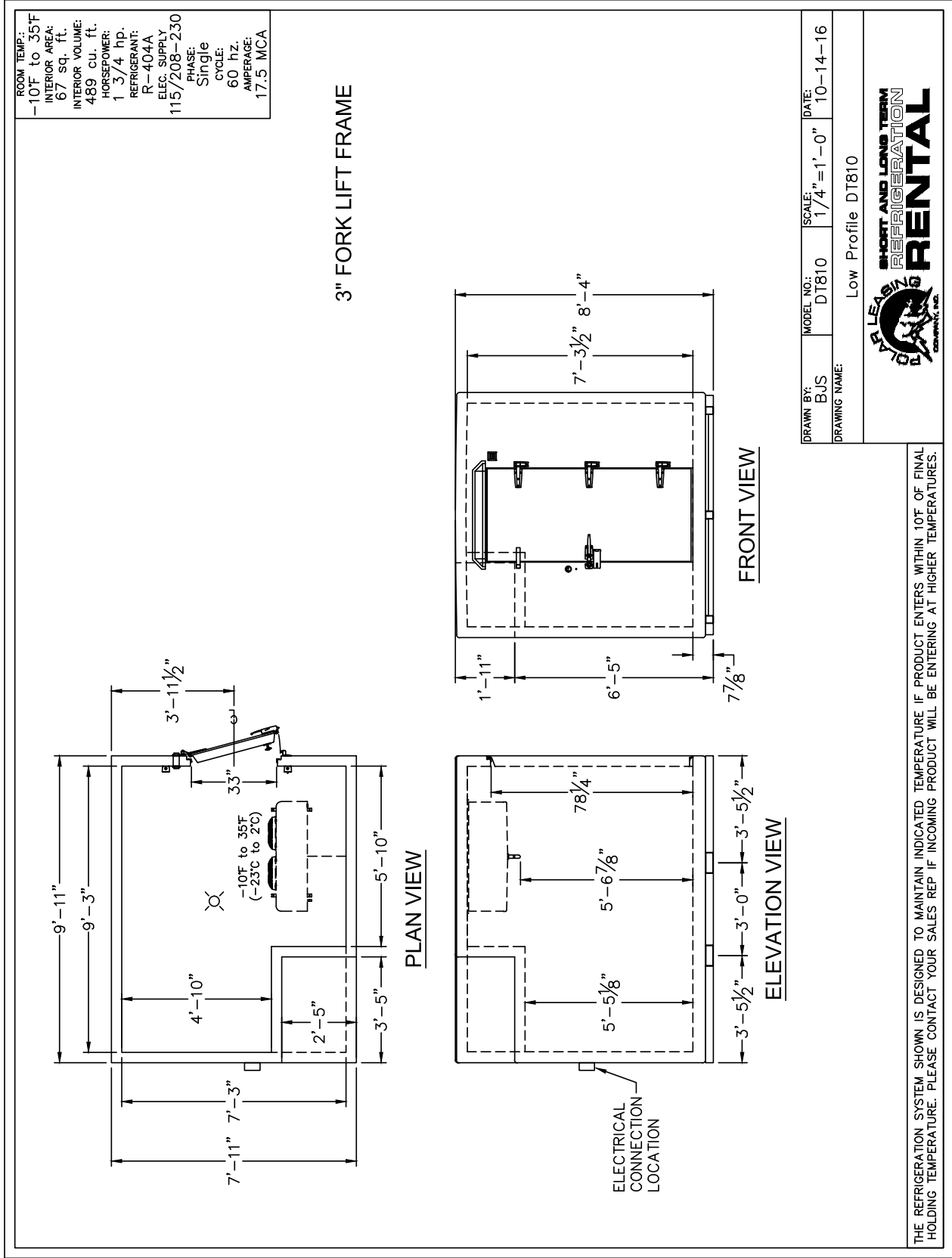



VALIDATION SUMMARY REPORT

Walk-in Refrigeration Storage / Cold Room

Title: Validation Summary Report for Walk-in Refrigeration / Cold Room Model DT820

Manufacturer:	Polar King International, Inc.
Model Number:	DT820
Equipment ID / Serial No:	917-8396

Revision Number: 1
Issue Date: 12/01/2017



Manufacturer:	Polar King International, Inc.
Model Number:	DT820
Equipment ID / Serial No:	917-8396

Table Of Contents

1.0	INTRODUCTION	3
2.0	REFERENCES	3
3.0	SUMMARY	3
3.1	INSTALLATION & QUALIFICATION	3
3.1.1	System Components Identification	3
3.1.2	Documentation Verification	3
3.1.3	Refrigeration System Components Visual Inspection.....	3
3.1.4	Electrical Supply Verification	3
3.1.5	Thermostatic Controller Identification	4
3.1.6	Refrigeration System Spare Parts	4
3.2	OPERATION QUALIFICATION.....	4
3.2.1	Vaisala Validation Equipment Calibration Verification	4
3.2.2	Temperature Data Logger Placement.....	4
3.2.3	24-HR Empty Unit Thermal Mapping (5°C Set Point)	5
3.2.4	Empty Unit Open Door Temperature Recovery (5°C Set Point).....	6
3.2.5	Empty Unit Power Failure Test (5°C Set Point)	7
3.2.6	24-HR Empty Unit Thermal Mapping (-20°C Set Point).....	7
3.2.7	Empty Unit Open Door Temperature Recovery (-20°C Set Point).....	8
3.2.8	Empty Unit Power Failure Test (-20°C Set Point)	8
3.3	Qualification Deviations	8
4.0	CONCLUSION	8
5.0	APPROVALS	9
6.0	Vaisala DL1000-1400 Specifications	10
7.0	Polar Leasing 8x20 Dual Temperature Unit Line Drawing	14



Title: Validation Summary Report for Walk-in Refrigeration / Cold Room Model DT820

Manufacturer:	Polar King International, Inc.
Model Number:	DT820
Equipment ID / Serial No:	917-8396

1.0 INTRODUCTION

The Validation Summary Report summarizes the qualification activities measured on the Walk-In Cold Room, Polar Leasing Unit #917-8396. The unit is manufactured by Polar King International, Inc. and has a model number of DT-820. It is controlled by a Johnson Controls thermostat model A419. This summary also covers any discrepancies encountered throughout the validation study.

2.0 REFERENCES

Temperature mapping of storage area, technical supplement to WHO Technical Report Series, No. 961, 2011.

3.0 SUMMARY

3.1 INSTALLATION & QULAIFICATION

The validation study for #917-8396 was completed on December 1st, 2017. Verifications for the study were documented and saved using Vaisala Veriteq vLog.

3.1.1 System Components Identification

Identification information for the Cold Room was verified. This included model and serial numbers for the condensing unit, compressor, and structure. Refrigerant type and expansion valve were confirmed, as was insulation thickness.

3.1.2 Documentation Verification

Documentation for installation and maintenance of #917-8396 was obtained. These documents were reviewed, and include manuals, CAD drawings, quality control reports and production worksheets.

3.1.3 Refrigeration System Components Visual Inspection

A visual inspection of refrigeration system components was conducted to verify the equipment was installed in accordance with the manufacturer's recommendation. Critical components were confirmed to be in new working order. No damage was noted.

3.1.4 Electrical Supply Verification

A Fluke Multimeter was used to confirm the provided voltage supply was in accordance with requirements specified on the serial plate of the Cold Room.



Manufacturer:	Polar King International, Inc.
Model Number:	DT820
Equipment ID / Serial No:	917-8396

3.1.5 Thermostatic Controller Identification

The installation location of the thermostatic control was noted and documented as required. All set points used for testing were documented as necessary.

3.1.6 Refrigeration System Spare Parts

No spare parts are required for the Validation Summary.

3.2 OPERATION QUALIFICATIONS

3.2.1 Vaisala Validation Equipment Calibration Verification

Calibration documentation for (19) Vaisala DL1000-1400 was reviewed and all temperature data loggers were found to be in calibration as required.

3.2.2 Temperature Data Logger Placement

The set-up of all temperature monitoring loggers was done in accordance with acceptable usage practices, obtaining measurements at multiple low, medium and high points within the Cold Room. A total of 19 data points were logged in each study, as shown in Figure 1.

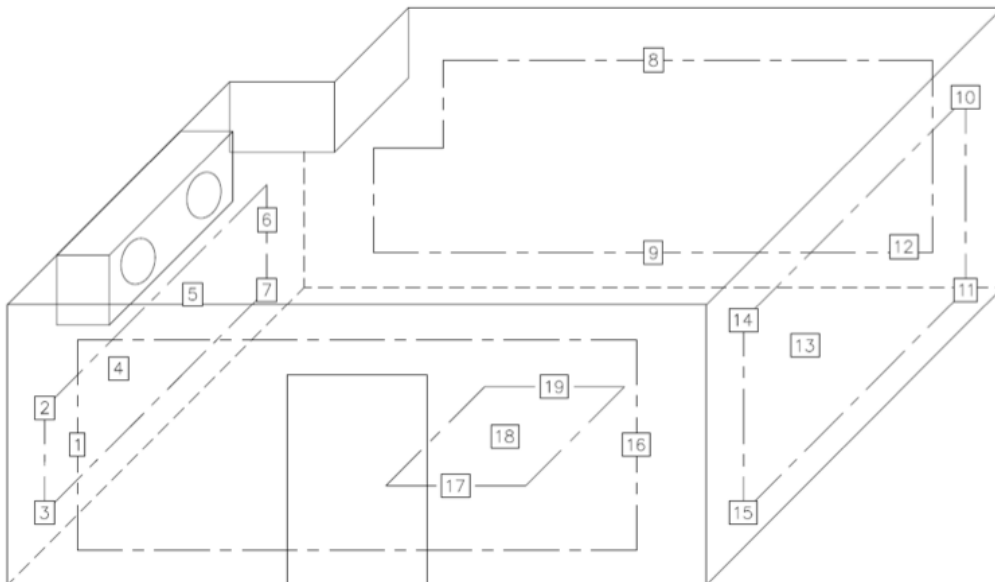

Figure 1



Manufacturer:	Polar King International, Inc.
Model Number:	DT820
Equipment ID / Serial No:	917-8396

Table 1: Temperature Data Logger Locations and Labels

Data Logger Location	Data Logger Label	Alternate Data Logger Label
1	VA Logger #1	17341013
2	VA Logger #2	17341014
3	VA Logger #3	17381125
4	VA Logger #4	17381130
5	VA Logger #5	17381127
6	VA Logger #6	17381085
7	VA Logger #7	17381084
8	VA Logger #8	17381124
9	VA Logger #9	17381128
10	VA Logger #10	17381126
11	VA Logger #11	17381086
12	VA Logger #12	17381082
13	VA Logger #13	17371094
14	VA Logger #14	17381121
15	VA Logger #15	17381122
16	VA Logger #16	16451060
17	VA Logger #17	17381123
18	VA Logger #18	17371120
19	VA Logger #19	17371109

3.2.3 24-HR Empty Unit Thermal Mapping (5°C Set Point)

At a set point of 5°C the Cold Room was tested empty, with the door closed. Temperature data loggers were positioned as shown in Figure 1. Temperature data was recorded for a 24 hr period, from 04:30pm EDT on 11/24/17 to 04:30pm EDT on 11/25/17. The data was logged at 2 minute intervals. Individual graph and data reports, as well as a summary data report have been included as appendices. The summarized data for all 19 temperature data loggers can be found in Table 2. No deviations were recorded during the test.



Manufacturer:	Polar King International, Inc.
Model Number:	DT820
Equipment ID / Serial No:	917-8396

Table 2: Temperature Data Logger Locations and Labels

Data Logger Location	Data Logger Label	Data Logger Label (Alternate)	Max Temp (°C)	Avg. Temp (°C)	Min Temp (°C)
1	VA Logger #1	17341013	5.67	4.90	3.81
2	VA Logger #2	17341014	5.72	4.86	3.43
3	VA Logger #3	17381125	5.59	4.77	3.46
4	VA Logger #4	17381130	5.67	4.87	3.83
5	VA Logger #5	17381127	5.36	4.73	4.02
6	VA Logger #6	17381085	5.31	4.76	4.32
7	VA Logger #7	17381084	5.29	4.72	4.23
8	VA Logger #8	17381124	5.48	4.69	3.78
9	VA Logger #9	17381128	5.77	4.99	4.42
10	VA Logger #10	17381126	5.27	4.67	4.17
11	VA Logger #11	17381086	5.29	4.74	4.28
12	VA Logger #12	17381082	5.47	4.61	3.89
13	VA Logger #13	17371094	5.59	4.63	3.36
14	VA Logger #14	17381121	5.75	4.88	3.72
15	VA Logger #15	17381122	5.68	4.83	3.68
16	VA Logger #16	16451060	5.71	4.88	3.85
17	VA Logger #17	17381123	5.54	4.90	4.44
18	VA Logger #18	17371120	5.42	4.70	3.81
19	VA Logger #19	17371109	5.43	4.82	4.24

3.2.4 Empty Unit Open Door Temperature Recovery (5°C Set Point)

The test was conducted between 08:07pm EDT and 09:07pm EDT on 12/01/17. Temperature was logged at 30-second intervals. After 25 minutes, no temperatures outside of the specification were recorded. The graphical and detailed report of internal and external data loggers is appended.



Manufacturer:	Polar King International, Inc.
Model Number:	DT820
Equipment ID / Serial No:	917-8396

3.2.5 Empty Unit Power Failure Test (5°C Set Point)

The test was conducted between 08:10am EDT and 11:15pm EDT on 11/30/17. Temperature was logged at 30-second intervals. The logged data showed the empty Cold Room, with the power supply disconnected; held temperature within the acceptable range for 2 hours and 36 minutes. The graphical report and data logs are appended. With restored power, the unit stabilized within the acceptable range in approximately 3 minutes.

3.2.6 24-HR Empty Unit Thermal Mapping (-20°C Set Point)

At a set point of -20°C the Cold Room was tested empty, with the door closed. Temperature data loggers were positioned as shown in Figure 1. Temperature data was recorded for a 24 hr period, from 08:00pm EDT on 11/22/17 to 08:00pm EDT on 11/23/17. The data was logged at 30-second intervals. Individual graph and data reports, as well as a summary data report have been included as appendices. The summarized data for all 19 temperature data loggers can be found in Table 3. No deviations were recorded during testing.

Data Logger Location	Data Logger Label	Alternate Data Logger Label	Max Temp (°C)	Avg. Temp (°C)	Min Temp (°C)
1	VA Logger #1	17341013	-15.90	-20.04	-20.78
2	VA Logger #2	17341014	-14.79	-20.03	-20.97
3	VA Logger #3	17381125	-15.79	-20.17	-21.25
4	VA Logger #4	17381130	-15.73	-20.08	-20.76
5	VA Logger #5	17381127	-16.27	-20.00	-20.57
6	VA Logger #6	17381085	-16.89	-20.00	-20.37
7	VA Logger #7	17381084	-16.88	-20.03	-20.51
8	VA Logger #8	17381124	-15.32	-19.73	-20.18
9	VA Logger #9	17381128	-15.86	-20.14	-20.81
10	VA Logger #10	17381126	-15.25	-19.95	-20.42
11	VA Logger #11	17381086	-16.86	-20.05	-20.44
12	VA Logger #12	17381082	-16.07	-20.37	-20.95
13	VA Logger #13	17371094	-15.61	-20.47	-21.47
14	VA Logger #14	17381121	-13.73	-20.01	-20.91
15	VA Logger #15	17381122	-15.82	-20.12	-20.96
16	VA Logger #16	16451060	-15.32	-20.02	-20.81
17	VA Logger #17	17381123	-16.92	-20.17	-20.54
18	VA Logger #18	17371120	-16.58	-20.14	-20.50
19	VA Logger #19	17371109	-16.53	-20.01	-20.38



Title: Validation Summary Report for Walk-in Refrigeration / Cold Room Model DT820

Manufacturer:	Polar King International, Inc.
Model Number:	DT820
Equipment ID / Serial No:	917-8396

3.2.7 Empty Unit Open Door Temperature Recovery (-20°C Set Point)

The test was conducted between 03:55pm EDT and 04:55pm EDT on 11/29/17. After 25 minutes, no temperatures outside of the specification were recorded. The graphical and detailed report of internal and external data loggers is appended.

3.2.8 Empty Unit Power Failure Test (-20°C Set Point)

The test was conducted between 08:01am EDT and 01:10pm EST on 11/28/17. Temperature was logged at 30-second intervals. The logged data showed the empty Cold Room, with the power supply disconnected, held temperature within the acceptable range for approximately 3 hours and 20 minutes. The graphical report and data logs are appended. With restored power, the unit stabilized within the acceptable range in approximately 3 minutes.

3.3 Qualification Deviations

No deviations were found during testing.

4.0 CONCLUSION

Temperature validation of #917-8396 was deemed a success without any deviations to report.



Title: Validation Summary Report for Walk-in Refrigeration / Cold Room Model DT820

Manufacturer:	Polar King International, Inc.
Model Number:	DT820
Equipment ID / Serial No:	917-8396

5.0 Approvals

In review of the collected data for this Validation Summary Report, this study has been deemed successfully completed with satisfactory results. All deviations are listed within the Validation Summary report and are available by request as appendices. The Polar Leasing unit #917-8396 has been successfully validated.

Name: David C. Schenkel Signature: [Signature]

Title: President Date: 1/24/18

Name: Todd Ellinger Signature: [Signature]

Title: VP Business Admin Date: 1-24-18

Polar Leasing Company Approvals:

The signatures below indicate a full review and understanding of the validation data, thus fully completing the requirements of the report.

Name: Bert Tippmann Signature: [Signature]

Title: President Date: 1-24-18

Name: _____ Signature: _____

Title: _____ Date: _____

Manufacturer:	Polar King International, Inc.
Model Number:	DT820
Equipment ID / Serial No:	917-8396

VAISALA

www.vaisala.com

Vaisala DL1000-1400 Temperature Data Logger



The 1000/1400 temperature data loggers include the VL-series for regulated environments and the SP-series for non FDA/GxP regulated industries. The VL-series of data loggers, together with vLog VL software, provide a superior, high accuracy solution for use in FDA/GxP regulated environments by ensuring tamperproof files and electronic records that meet 21 CFR Part 11 requirements. The SP-series provides a compact, easily deployable, highly

accurate measurement and recording device. Coupled with vLog SP software for downloading, displaying, analyzing and reporting of recorded environmental data, the SP-series was designed for use in non FDA/GxP regulated environments. Optional browser-based viewLinc software provides 24/7 multi-stage alarm notification and remote monitoring for both the VL and SP series of data loggers.

Features/Benefits

- Industry-leading precision and accuracy
- Printed reports for any time period
- 10-year battery
- Validation and continuous monitoring with the same model
- Two year limited warranty
- Superior alternative to chart recorders and hard-wired systems
- Traceable to SI units through national metrology institutes.*
- Timebase calibrated over the operating temperature range
- Adjustable time based recording
- Snap-in logger cradle for easy network connectivity
- Two probe options give high accuracy – from -90 °C to +70 °C

* Measurement results are traceable to the international system of units (SI) through national metrology institutes (NIST USA, MIKES Finland, or equivalent) or ISO/IEC 17025 accredited calibration laboratories.

Applications

Ideal for Monitoring & Validation of:

- Refrigerators & Freezers (to -90 °C)
- Incubators
- Stability Chambers
- Warehouses
- Ambient conditions



Title: Validation Summary Report for Walk-in Refrigeration / Cold Room Model DT820

Manufacturer:	Polar King International, Inc.
Model Number:	DT820
Equipment ID / Serial No:	917-8396

Technical Data

General

Size	85 x 59 x 26 mm (3.4 x 2.3 x 1") 76 g (2.7oz)
Interfaces	RS-232 serial, USB, Ethernet, WiFi, PoE network interface available
Mounting	3M Dual Lock™ Fasteners Snap-in connector locks provide secure probe connections
PC Software	Graphing & Reporting Software vLog SP for SP-series vLog VL for VL-series viewLinc for continuous monitoring & alarming OPC Server to add on to existing OPC compatible monitoring systems
Internal Clock	Accuracy ±1 min. /month -25 °C to +70 °C (-13 °F to +158 °F)
Electromagnetic Compatibility	FCC Part 15 and CE
Power Source	Internal 10-year lithium battery (Battery life specified with sample interval of 1 min. or longer)
Logger Operating/Storage Range	-40 °C to +85 °C (-40 °F to +185 °F) 0 %RH to 100 %RH non-condensing

Internal Temperature Sensor

Series	Sensor Type
1000-21x	Precision-tolerance epoxy-encapsulated NTC thermistor

Memory

Data Sample Capacity	
1000-2XX	48,100 12-bit samples
1400-44X	85,300 12-bit samples
Memory Type	Non-volatile EEPROM
Memory Modes	User selectable: wrap (FIFO) or stop when memory is full. User selectable start time. User selectable stop time (VL series only).
Sampling Rates	User-selectable (in 10 second intervals) from once every 10 seconds to once a day.

Recording Span: 1000-2xx

SAMPLE INTERVAL	NUMBER OF CHANNELS ENABLED	
	1	2
10 Seconds	5.5 Days	2.7 Days
1 Minute	1.1 Months	16.7 Days
5 Minutes	5.5 Months	2.7 Months
15 Minutes	1.3 Years	8.3 Months
1 Hour	5.4 Years	2.7 Years



VL-1000-21x



VL-1000-22x

Recording Span: 1400-44x

SAMPLE INTERVAL	NUMBER OF CHANNELS ENABLED			
	1	2	3	4
10 Seconds	9.8 Days	4.9 Days	3.2 Days	2.4 Days
1 Minute	1.9 Months	29.6 Days	19.7 Days	14.8 Days
5 Minutes	9.8 Months	4.9 Months	3.2 Months	2.4 Months
15 Minutes	2.4 Years	1.2 Years	9.8 Months	7.4 Months
1 Hour	9.7 Years	4.8 Years	3.2 Years	2.4 Years



VL-1400-44x



Manufacturer:	Polar King International, Inc.
Model Number:	DT820
Equipment ID / Serial No:	917-8396

EPT Series Temperature Probes

Sensor Models

"N" Range External Probes	EPT-23N-XXN and EPT-22W-XXN
Operating/Storage Range	-40 °C to +95 °C (-40 °F to +203 °F)
Connector Color Code	Black
"V" Range External Probes	EPT-23N-XXV and EPT-22W-XXV
Operating/Storage Range	-95 °C to +95 °C (-139 °F to +203 °F)
Connector Color Code	Blue

EPT - XXX - XXX

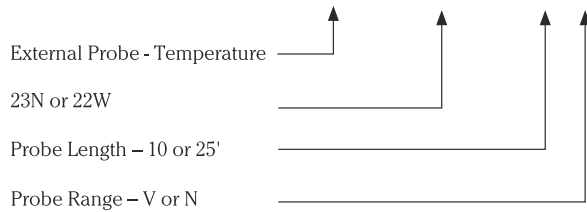

Sensor Tips

EPT-23N-XXX	Stainless Steel Diameter 3.2 mm (1/8") °F Length 38 mm (1.5")
EPT-22W-XXX (liquid submersible)	Sealed Teflon Tip Diameter 3 mm (0.12") Length 28 mm (1.1")
Probe Lengths	3 m (10') and 7.6 m (25')
Cable Construction	2mm (0.07") Diameter Teflon coated cable

Temperature Probe Accessories

Thermal Dampening Block, for use in refrigerators and freezers, simulates a glycol bottle to reduce viewLinc alarms generated by opening and closing a door.





Title: Validation Summary Report for Walk-in Refrigeration / Cold Room Model DT820

Manufacturer:	Polar King International, Inc.
Model Number:	DT820
Equipment ID / Serial No:	917-8396

Product Part Number Legend: Guide for reading the product tables and selecting the most appropriate model for your application.

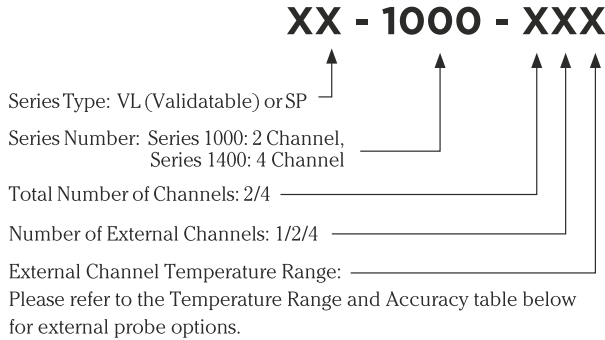

Temperature Range and Accuracy

Internal Sensor

Calibrated	
Measurement Range	-25 °C to +70 °C (-13 °F to +158 °F)
Operating/Storage Range	-40 °C to +85 °C (-40 °F to +185 °F)
0 %RH to 100 %RH non-condensing	
Initial Accuracy	+/-0.10 °C over +20 °C to +30 °C (+/-0.18 °F over +68 °F to +86 °F) +/- 0.2 °C over -25 °C to +70 °C (+/- 0.36 °F over -13 °F to +158 °F)
One Year Accuracy	+/-0.15 °C over +20 °C to +30 °C (+/-0.27 °F over +68 °F to +86 °F) +/-0.25 °C over -25 °C to +70 °C (+/-0.45 °F over -13 °F to +158 °F)
Resolution	0.02 °C at +25 °C (0.04 °F at +77 °F)

External Probes - All Models

"N" RANGE EXTERNAL PROBE	
Calibrated	
Measurement Range	-25 °C to +70 °C (-13 °F to +158 °F)
Operating/Storage Range	-40 °C to +95 °C (-40 °F to +203 °F)
Initial Accuracy*	+/-0.10 °C over +20 °C to +30 °C (+/-0.18 °F over +68 °F to +86 °F) +/-0.15 °C over -25 °C to +70 °C (+/-0.27 °F over -13 °F to +158 °F)
One Year Accuracy*	+/-0.2 °C over +20 °C to +30 °C (+/-0.36 °F over +68 °F to +86 °F) +/-0.25 °C over -25 °C to +70 °C (+/-0.45 °F over -13 °F to +158 °F)
Resolution	0.02 °C at +25 °C (0.04 °F at +77 °F)

"V" RANGE EXTERNAL PROBE	
Calibrated	
Measurement Range	-90 °C to -40 °C (-130 °F to -40 °F)
Operating/Storage Range	-95 °C to +95 °C (-139 °F to +203 °F)
Initial Accuracy*	+/- 0.2 °C over -90 °C to -40 °C (+/- 0.36 °F over -130 °F to -40 °F)
One Year Accuracy*	+/-0.25 °C over -90 °C to -40 °C (+/-0.45 °F over -130 °F to -40 °F)
Resolution	0.02 °C at -80 °C (0.04 °F at -112 °F)

*Specification for external channels is for a probe calibrated to the specific channel of the data logger and with the data logger at -25 °C to +70 °C (-13 °F to +158 °F)



www.vaisala.com

Please contact us at
www.vaisala.com/requestinfo



Scan the code for more information

Ref. B211044EN-D ©Vaisala 2017
This material is subject to copyright protection, with all copyrights retained by Vaisala and its individual partners. All rights reserved. Any logos and/or product names are trademarks of Vaisala or its individual partners. The reproduction, transfer, distribution or storage of information contained in this brochure in any form without the prior written consent of Vaisala is strictly prohibited. All specifications — technical included — are subject to change without notice.





Manufacturer:	Polar King International, Inc.
Model Number:	DT820
Equipment ID / Serial No:	917-8396

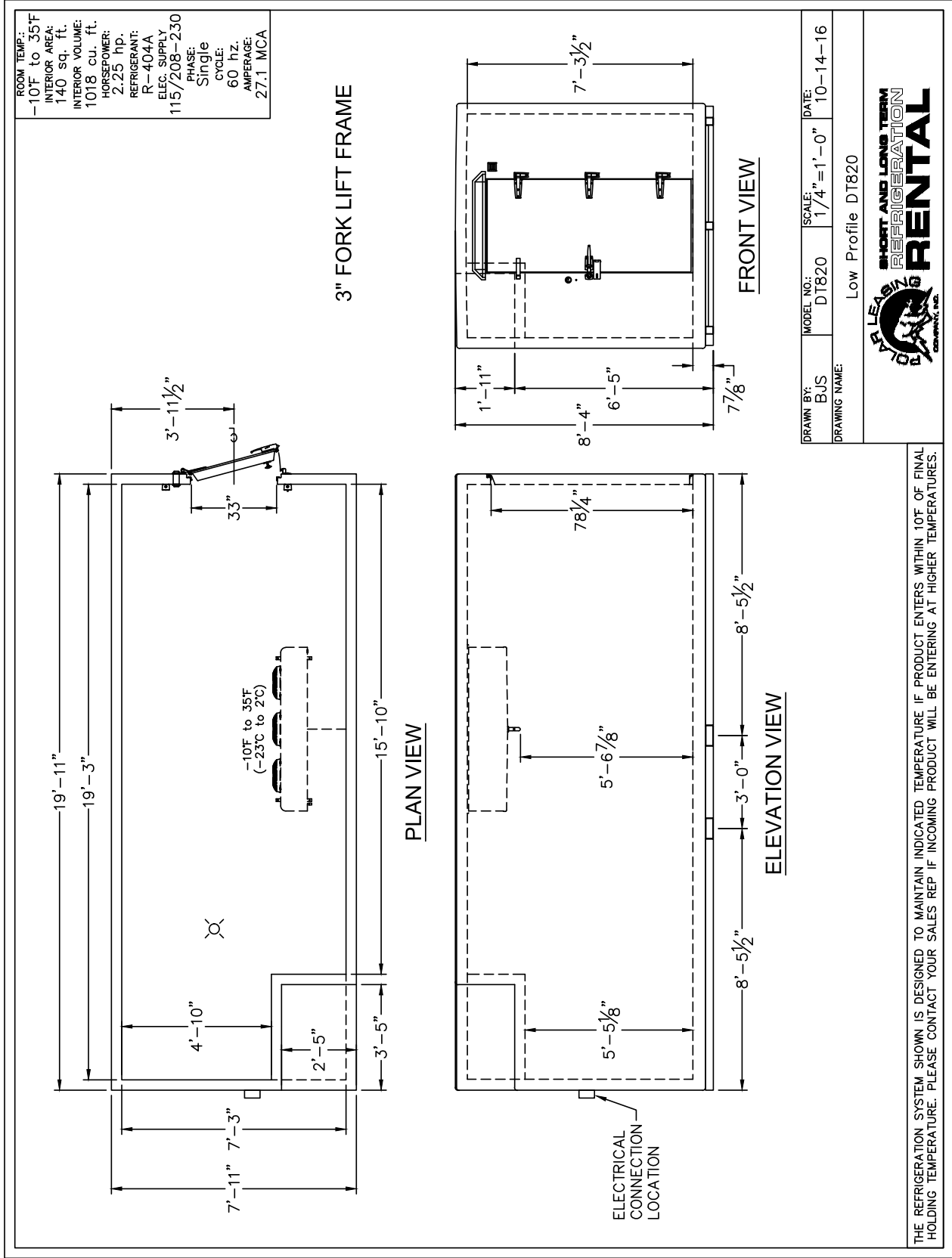



VALIDATION SUMMARY REPORT

Walk-in Refrigeration Storage / Cold Room

Title: Validation Summary Report for Walk-in Refrigeration / Cold Room Model DT820RP

Manufacturer:	Polar King International, Inc.
Model Number:	DT820RP
Equipment ID / Serial No:	917-8168

Revision Number: 1
Issue Date: 03/09/2018



Manufacturer:	Polar King International, Inc.
Model Number:	DT820RP
Equipment ID / Serial No:	917-8168

Table Of Contents

1.0	INTRODUCTION	3
2.0	REFERENCES	3
3.0	SUMMARY	3
3.1	INSTALLATION & QUALIFICATION	3
3.1.1	System Components Identification	3
3.1.2	Documentation Verification	3
3.1.3	Refrigeration System Components Visual Inspection.....	3
3.1.4	Electrical Supply Verification	3
3.1.5	Thermostatic Controller Identification	4
3.1.6	Refrigeration System Spare Parts	4
3.2	OPERATION QUALIFICATION.....	4
3.2.1	Vaisala Validation Equipment Calibration Verification	4
3.2.2	Temperature Data Logger Placement.....	4
3.2.3	24-HR Empty Unit Thermal Mapping (5°C Set Point)	5
3.2.4	Empty Unit Open Door Temperature Recovery (5°C Set Point).....	6
3.2.5	Empty Unit Power Failure Test (5°C Set Point)	7
3.2.6	24-HR Empty Unit Thermal Mapping (-20°C Set Point).....	7
3.2.7	Empty Unit Open Door Temperature Recovery (-20°C Set Point).....	8
3.2.8	Empty Unit Power Failure Test (-20°C Set Point)	8
3.3	Qualification Deviations	8
4.0	CONCLUSION	8
5.0	APPROVALS	9
6.0	Vaisala DL1000-1400 Specifications	10
7.0	Polar Leasing 8x20RP Dual Temperature Unit Line Drawing	14



Title: Validation Summary Report for Walk-in Refrigeration / Cold Room Model DT820RP

Manufacturer:	Polar King International, Inc.
Model Number:	DT820RP
Equipment ID / Serial No:	917-8168

1.0 INTRODUCTION

The Validation Summary Report summarizes the qualification activities measured on the Walk-In Cold Room with redundant refrigeration systems, Polar Leasing Unit #917-8168. The unit is manufactured by Polar King International, Inc. and has a model number of DT820RP. It is controlled by a Therm Solutions KE2 refrigeration control. This summary also covers any discrepancies encountered throughout the validation study.

2.0 REFERENCES

Temperature mapping of storage area, technical supplement to WHO Technical Report Series, No. 961, 2011.

3.0 SUMMARY

3.1 INSTALLATION & QULAIFICATION

The validation study for #917-8168 was completed on March 3rd, 2018. Verifications for the study were documented and saved using Vaisala Veriteq vLog.

3.1.1 System Components Identification

Identification information for the Cold Room was verified. This included model and serial numbers for the condensing unit, compressor, and structure. Refrigerant type and expansion valve were confirmed, as was insulation thickness.

3.1.2 Documentation Verification

Documentation for installation and maintenance of #917-8168 was obtained. These documents were reviewed, and include manuals, CAD drawings, quality control reports and production worksheets.

3.1.3 Refrigeration System Components Visual Inspection

A visual inspection of refrigeration system components was conducted to verify the equipment was installed in accordance with the manufacturer’s recommendation. Critical components were confirmed to be in new working order. No damage was noted.

3.1.4 Electrical Supply Verification

A Fluke Multimeter was used to confirm the provided voltage supply was in accordance with requirements specified on the serial plate of the Cold Room.



Manufacturer:	Polar King International, Inc.
Model Number:	DT820RP
Equipment ID / Serial No:	917-8168

3.1.5 Thermostatic Controller Identification

The installation location of two thermostatic controls was noted and documented as required. Vaisala temperature data loggers #4 and #7 were used to log data at thermocouple locations. All set points used for testing were documented as necessary.

3.1.6 Refrigeration System Spare Parts

No spare parts are required for the Validation Summary.

3.2 OPERATION QUALIFICATIONS

3.2.1 Vaisala Validation Equipment Calibration Verification

Calibration documentation for (17) Vaisala DL1000-1400 was reviewed and all temperature data loggers were found to be in calibration as required.

3.2.2 Temperature Data Logger Placement

The set-up of all temperature monitoring loggers was done in accordance with acceptable usage practices, obtaining measurements at multiple low, medium and high points within the Cold Room. A total of 17 data points were logged in each study, as shown in Figure 1.

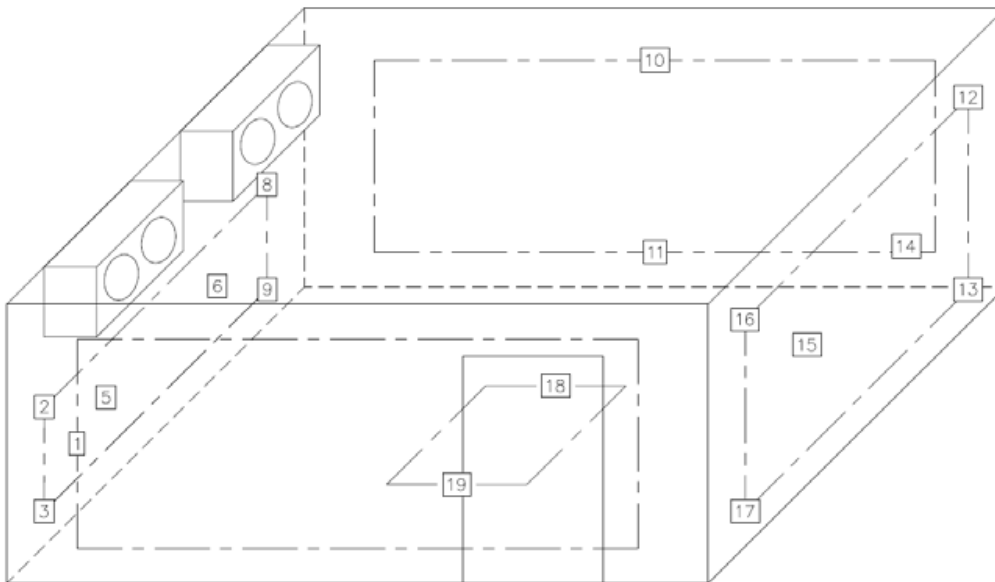

Figure 1



Manufacturer:	Polar King International, Inc.
Model Number:	DT820RP
Equipment ID / Serial No:	917-8168

Table 1: Temperature Data Logger Locations and Labels

Data Logger Location	Data Logger Label	Alternate Data Logger Label
1	VA Logger #1	17341013
2	VA Logger #2	17341014
3	VA Logger #3	17381125
5	VA Logger #5	17381127
6	VA Logger #6	17381085
8	VA Logger #8	17381124
9	VA Logger #9	17381128
10	VA Logger #10	17381126
11	VA Logger #11	17381086
12	VA Logger #12	17381082
13	VA Logger #13	17371094
14	VA Logger #14	17381121
15	VA Logger #15	17381122
16	VA Logger #16	16451060
17	VA Logger #17	17381123
18	VA Logger #18	17371120
19	VA Logger #19	17371109

3.2.3 24-HR Empty Unit Thermal Mapping (5°C Set Point)

At a set point of 5°C the Cold Room was tested empty, with the door closed. Temperature data loggers were positioned as shown in Figure 1. Temperature data was recorded for a 24 hr period, from 12:00pm EST on 03/01/18 to 12:00pm EST on 03/02/18. The data was logged at 30 second intervals. Individual graph and data reports, as well as a summary data report have been included as appendices. No deviations were recorded during testing. The summarized data for all 17 temperature data loggers can be found in Table 2.



Manufacturer:	Polar King International, Inc.
Model Number:	DT820RP
Equipment ID / Serial No:	917-8168

Table 2: Temperature Data Logger Locations and Labels

Data Logger Location	Data Logger Label	Data Logger Label (Alternate)	Max Temp (°C)	Avg. Temp (°C)	Min Temp (°C)
1	VA Logger #1	17341013	5.53	4.89	4.36
2	VA Logger #2	17341014	5.95	5.00	4.17
3	VA Logger #3	17381125	5.45	4.70	3.89
5	VA Logger #5	17381127	5.13	4.54	3.85
6	VA Logger #6	17381085	4.65	4.36	3.90
8	VA Logger #8	17381124	4.80	4.50	4.09
9	VA Logger #9	17381128	4.75	4.37	3.87
10	VA Logger #10	17381126	4.85	4.57	4.19
11	VA Logger #11	17381086	4.68	4.41	4.05
12	VA Logger #12	17381082	4.79	4.43	4.01
13	VA Logger #13	17371094	4.77	4.50	4.16
14	VA Logger #14	17381121	4.65	4.37	3.99
15	VA Logger #15	17381122	5.03	4.45	3.90
16	VA Logger #16	16451060	6.42	5.17	3.92
17	VA Logger #17	17381123	5.98	5.03	4.34
18	VA Logger #18	17371120	4.74	4.46	4.15
19	VA Logger #19	17371109	5.48	4.73	4.19

3.2.4 Empty Unit Open Door Temperature Recovery (5°C Set Point)

The test was conducted between 10:22am EST and 10:47am EST on 03/01/18. After 25 minutes, only two temperature data loggers showed temperatures outside of specification, while test criteria required at least 50% of data loggers to do so. The test was terminated after 25 minutes, as door openings of this length are well outside of the scope of use. The graphical and detailed report of internal and external data loggers is appended.



Manufacturer:	Polar King International, Inc.
Model Number:	DT820RP
Equipment ID / Serial No:	917-8168

3.2.5 Empty Unit Power Failure Test (5°C Set Point)

The test was conducted between 03:27pm EST and 06:00pm EST on 03/02/18. Temperature was logged at 30 second intervals. The logged data showed the empty Cold Room, with the power supply disconnected; held temperature within the acceptable range for 1 hour and 38 minutes when exposed to an average ambient temperature of 25.5°C (78°F). With restored power, the unit stabilized within the acceptable range in approximately 3 minutes. The graphical report and data logs are appended.

3.2.6 24-HR Empty Unit Thermal Mapping (-20°C Set Point)

At a set point of -20°C the Cold Room was tested empty, with the door closed. Temperature data loggers were positioned as shown in Figure 1. Temperature data was recorded for a 24 hr period, from 11:59pm EST on 02/26/18 to 11:59pm EST on 02/27/18. The data was logged at 30-second intervals. Individual graph and data reports, as well as a summary data report have been included as appendices. The summarized data for all 17 temperature data loggers can be found in Table 3. No deviations were recorded during testing.

Data Logger Location	Data Logger Label	Alternate Data Logger Label	Max Temp (°C)	Avg. Temp (°C)	Min Temp (°C)
1	VA Logger #1	17341013	-16.84	-18.95	-20.73
2	VA Logger #2	17341014	-16.40	-18.93	-20.75
3	VA Logger #3	17381125	-16.91	-19.13	-21.03
5	VA Logger #5	17381127	-16.67	-19.37	-20.84
6	VA Logger #6	17381085	-17.68	-19.55	-20.53
8	VA Logger #8	17381124	-17.72	-19.48	-21.15
9	VA Logger #9	17381128	-17.84	-19.55	-21.25
10	VA Logger #10	17381126	-17.79	-19.41	-21.13
11	VA Logger #11	17381086	-18.00	-19.50	-20.99
12	VA Logger #12	17381082	-18.21	-19.69	-21.23
13	VA Logger #13	17371094	-17.99	-19.60	-21.14
14	VA Logger #14	17381121	-18.08	-19.77	-21.08
15	VA Logger #15	17381122	-17.13	-19.53	-21.02
16	VA Logger #16	16451060	-16.34	-19.05	-20.97
17	VA Logger #17	17381123	-17.06	-18.85	-20.49
18	VA Logger #18	17371120	-17.83	-19.56	-20.72
19	VA Logger #19	17371109	-17.04	-19.00	-20.44



Title: Validation Summary Report for Walk-in Refrigeration / Cold Room Model DT820RP

Manufacturer:	Polar King International, Inc.
Model Number:	DT820RP
Equipment ID / Serial No:	917-8168

3.2.7 Empty Unit Open Door Temperature Recovery (-20°C Set Point)

The test was conducted between 02:55pm EST and 03:20pm EST on 02/16/18. After 25 minutes, no data loggers showed temperatures outside of specification. The test was terminated, as door openings of this length are well outside of the scope of use. The graphical and detailed report of internal and external data loggers is appended.

3.2.8 Empty Unit Power Failure Test (-20°C Set Point)

The test was conducted between 11:45am EST and 04:17pm EST on 02/23/18. Temperature was logged at 30-second intervals. The logged data showed the empty Cold Room, with the power supply disconnected, held temperature within the acceptable range for approximately 3 hours and 45 minutes when exposed to an average ambient temperature of 24.5°C (74°F). With restored power, the unit stabilized within the acceptable range in approximately 5 minutes. The graphical report and data logs are appended.

3.3 Qualification Deviations

No deviations were found during testing.

4.0 CONCLUSION

Temperature validation of #917-8168 was deemed a success without any deviations to report.



Title: Validation Summary Report for Walk-in Refrigeration / Cold Room Model DT820RP

Manufacturer:	Polar King International, Inc.
Model Number:	DT820RP
Equipment ID / Serial No:	917-8168

5.0 Approvals

In review of the collected data for this Validation Summary Report, this study has been deemed successfully completed with satisfactory results. All deviations are listed within the Validation Summary report and are available by request as appendices. The Polar Leasing unit #917-8168 has been successfully validated.

Name: David Schenk Signature: David Schenk

Title: President Date: 4/9/18

Name: Todd Ellinger Signature: [Signature]

Title: VP Business Administration Date: 4-9-18

Polar Leasing Company Approvals:

The signatures below indicate a full review and understanding of the validation data, thus fully completing the requirements of the report.

Name: Bart Tippman Signature: [Signature]

Title: President Date: 4/9/18

Name: _____ Signature: _____

Title: _____ Date: _____

Manufacturer:	Polar King International, Inc.
Model Number:	DT820RP
Equipment ID / Serial No:	917-8168



Vaisala DL1000-1400 Temperature Data Logger



The 1000/1400 temperature data loggers include the VL-series for regulated environments and the SP-series for non FDA/GxP regulated industries. The VL-series of data loggers, together with vLog VL software, provide a superior, high accuracy solution for use in FDA/GxP regulated environments by ensuring tamperproof files and electronic records that meet 21 CFR Part 11 requirements. The SP-series provides a compact, easily deployable, highly

accurate measurement and recording device. Coupled with vLog SP software for downloading, displaying, analyzing and reporting of recorded environmental data, the SP-series was designed for use in non FDA/GxP regulated environments. Optional browser-based viewLinc software provides 24/7 multi-stage alarm notification and remote monitoring for both the VL and SP series of data loggers.

Features/Benefits

- Industry-leading precision and accuracy
- Printed reports for any time period
- 10-year battery
- Validation and continuous monitoring with the same model
- Two year limited warranty
- Superior alternative to chart recorders and hard-wired systems
- Traceable to SI units through national metrology institutes.*
- Timebase calibrated over the operating temperature range
- Adjustable time based recording
- Snap-in logger cradle for easy network connectivity
- Two probe options give high accuracy - from -90 °C to +70 °C

* Measurement results are traceable to the international system of units (SI) through national metrology institutes (NIST USA, MIKES Finland, or equivalent) or ISO/IEC 17025 accredited calibration laboratories.

Applications

- Ideal for Monitoring & Validation of:
- Refrigerators & Freezers (to -90 °C)
 - Incubators
 - Stability Chambers
 - Warehouses
 - Ambient conditions



Title: Validation Summary Report for Walk-in Refrigeration / Cold Room Model DT820RP

Manufacturer:	Polar King International, Inc.
Model Number:	DT820RP
Equipment ID / Serial No:	917-8168

Technical Data

General

Size	85 x 59 x 26 mm (3.4 x 2.3 x 1") 76 g (2.7oz)
Interfaces	RS-232 serial, USB, Ethernet, WiFi, PoE network interface available
Mounting	3M Dual Lock™ Fasteners Snap-in connector locks provide secure probe connections
PC Software	Graphing & Reporting Software vLog SP for SP-series vLog VL for VL-series viewLinc for continuous monitoring & alarming OPC Server to add on to existing OPC compatible monitoring systems
Internal Clock	Accuracy ±1 min. /month -25 °C to +70 °C (-13 °F to +158 °F)
Electromagnetic Compatibility	FCC Part 15 and CE
Power Source	Internal 10-year lithium battery (Battery life specified with sample interval of 1 min. or longer)
Logger Operating/Storage Range	-40 °C to +85 °C (-40 °F to +185 °F) 0 %RH to 100 %RH non-condensing

Internal Temperature Sensor

Series	Sensor Type
1000-21x	Precision-tolerance epoxy-encapsulated NTC thermistor

Memory

Data Sample Capacity	
1000-2XX	48,100 12-bit samples
1400-44X	85,300 12-bit samples
Memory Type	Non-volatile EEPROM
Memory Modes	User selectable: wrap (FIFO) or stop when memory is full. User selectable start time. User selectable stop time (VL series only).
Sampling Rates	User-selectable (in 10 second intervals) from once every 10 seconds to once a day.

Recording Span: 1000-2xx

SAMPLE INTERVAL	NUMBER OF CHANNELS ENABLED	
	1	2
10 Seconds	5.5 Days	2.7 Days
1 Minute	1.1 Months	16.7 Days
5 Minutes	5.5 Months	2.7 Months
15 Minutes	1.3 Years	8.3 Months
1 Hour	5.4 Years	2.7 Years



VL-1000-21x



VL-1000-22x

Recording Span: 1400-44x

SAMPLE INTERVAL	NUMBER OF CHANNELS ENABLED			
	1	2	3	4
10 Seconds	9.8 Days	4.9 Days	3.2 Days	2.4 Days
1 Minute	1.9 Months	29.6 Days	19.7 Days	14.8 Days
5 Minutes	9.8 Months	4.9 Months	3.2 Months	2.4 Months
15 Minutes	2.4 Years	1.2 Years	9.8 Months	7.4 Months
1 Hour	9.7 Years	4.8 Years	3.2 Years	2.4 Years



VL-1400-44x



Manufacturer:	Polar King International, Inc.
Model Number:	DT820RP
Equipment ID / Serial No:	917-8168

EPT Series Temperature Probes

Sensor Models

"N" Range External Probes	EPT-23N-XXN and EPT-22W-XXN
Operating/Storage Range	-40 °C to +95 °C (-40 °F to +203 °F)
Connector Color Code	Black
"V" Range External Probes	EPT-23N-XXV and EPT-22W-XXV
Operating/Storage Range	-95 °C to +95 °C (-139 °F to +203 °F)
Connector Color Code	Blue

EPT - XXX - XXX

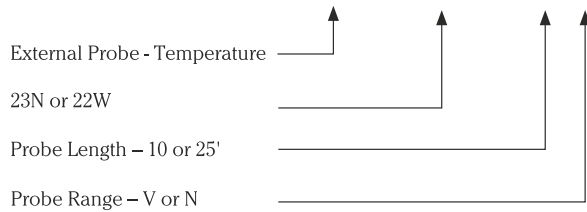

Sensor Tips

EPT-23N-XXX	Stainless Steel Diameter 3.2 mm (1/8") °F Length 38 mm (1.5")
EPT-22W-XXX (liquid submersible)	Sealed Teflon Tip Diameter 3 mm (0.12") Length 28 mm (1.1")
Probe Lengths	3 m (10') and 7.6 m (25')
Cable Construction	2mm (0.07") Diameter Teflon coated cable

Temperature Probe Accessories

Thermal Dampening Block, for use in refrigerators and freezers, simulates a glycol bottle to reduce viewLinc alarms generated by opening and closing a door.





Title: Validation Summary Report for Walk-in Refrigeration / Cold Room Model DT820RP

Manufacturer:	Polar King International, Inc.
Model Number:	DT820RP
Equipment ID / Serial No:	917-8168

Product Part Number Legend: Guide for reading the product tables and selecting the most appropriate model for your application.

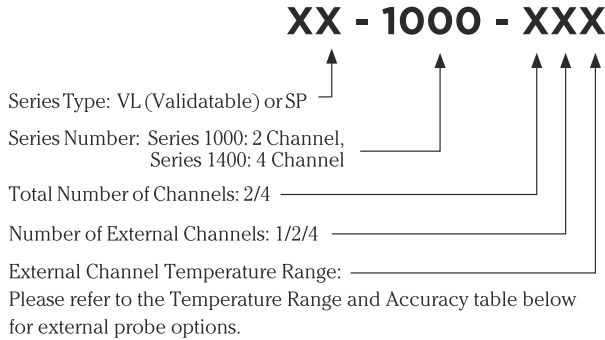

Temperature Range and Accuracy

Internal Sensor

Calibrated	
Measurement Range	-25 °C to +70 °C (-13 °F to +158 °F)
Operating/Storage Range	-40 °C to +85 °C (-40 °F to +185 °F)
0 %RH to 100 %RH non-condensing	
Initial Accuracy	+/-0.10 °C over +20 °C to +30 °C (+/-0.18 °F over +68 °F to +86 °F) +/- 0.2 °C over -25 °C to +70 °C (+/- 0.36 °F over -13 °F to +158 °F)
One Year Accuracy	+/-0.15 °C over +20 °C to +30 °C (+/-0.27 °F over +68 °F to +86 °F) +/-0.25 °C over -25 °C to +70 °C (+/-0.45 °F over -13 °F to +158 °F)
Resolution	0.02 °C at +25 °C (0.04 °F at +77 °F)

External Probes - All Models

"N" RANGE EXTERNAL PROBE	
Calibrated	
Measurement Range	-25 °C to +70 °C (-13 °F to +158 °F)
Operating/Storage Range	-40 °C to +95 °C (-40 °F to +203 °F)
Initial Accuracy*	+/-0.10 °C over +20 °C to +30 °C (+/-0.18 °F over +68 °F to +86 °F) +/-0.15 °C over -25 °C to +70 °C (+/-0.27 °F over -13 °F to +158 °F)
One Year Accuracy*	+/-0.2 °C over +20 °C to +30 °C (+/-0.36 °F over +68 °F to +86 °F) +/-0.25 °C over -25 °C to +70 °C (+/-0.45 °F over -13 °F to +158 °F)
Resolution	0.02 °C at +25 °C (0.04 °F at +77 °F)
"V" RANGE EXTERNAL PROBE	
Calibrated	
Measurement Range	-90 °C to -40 °C (-130 °F to -40 °F)
Operating/Storage Range	-95 °C to +95 °C (-139 °F to +203 °F)
Initial Accuracy*	+/- 0.2 °C over -90 °C to -40 °C (+/- 0.36 °F over -130 °F to -40 °F)
One Year Accuracy*	+/-0.25 °C over -90 °C to -40 °C (+/-0.45 °F over -130 °F to -40 °F)
Resolution	0.02 °C at -80 °C (0.04 °F at -112 °F)

*Specification for external channels is for a probe calibrated to the specific channel of the data logger and with the data logger at -25 °C to +70 °C (-13 °F to +158 °F)



www.vaisala.com

Please contact us at
www.vaisala.com/requestinfo



Scan the code for more information

Ref. B211044EN-D ©Vaisala 2017
This material is subject to copyright protection, with all copyrights retained by Vaisala and its individual partners. All rights reserved. Any logos and/or product names are trademarks of Vaisala or its individual partners. The reproduction, transfer, distribution or storage of information contained in this brochure in any form without the prior written consent of Vaisala is strictly prohibited. All specifications — technical included — are subject to change without notice.





Manufacturer:	Polar King International, Inc.
Model Number:	DT820RP
Equipment ID / Serial No:	917-8168

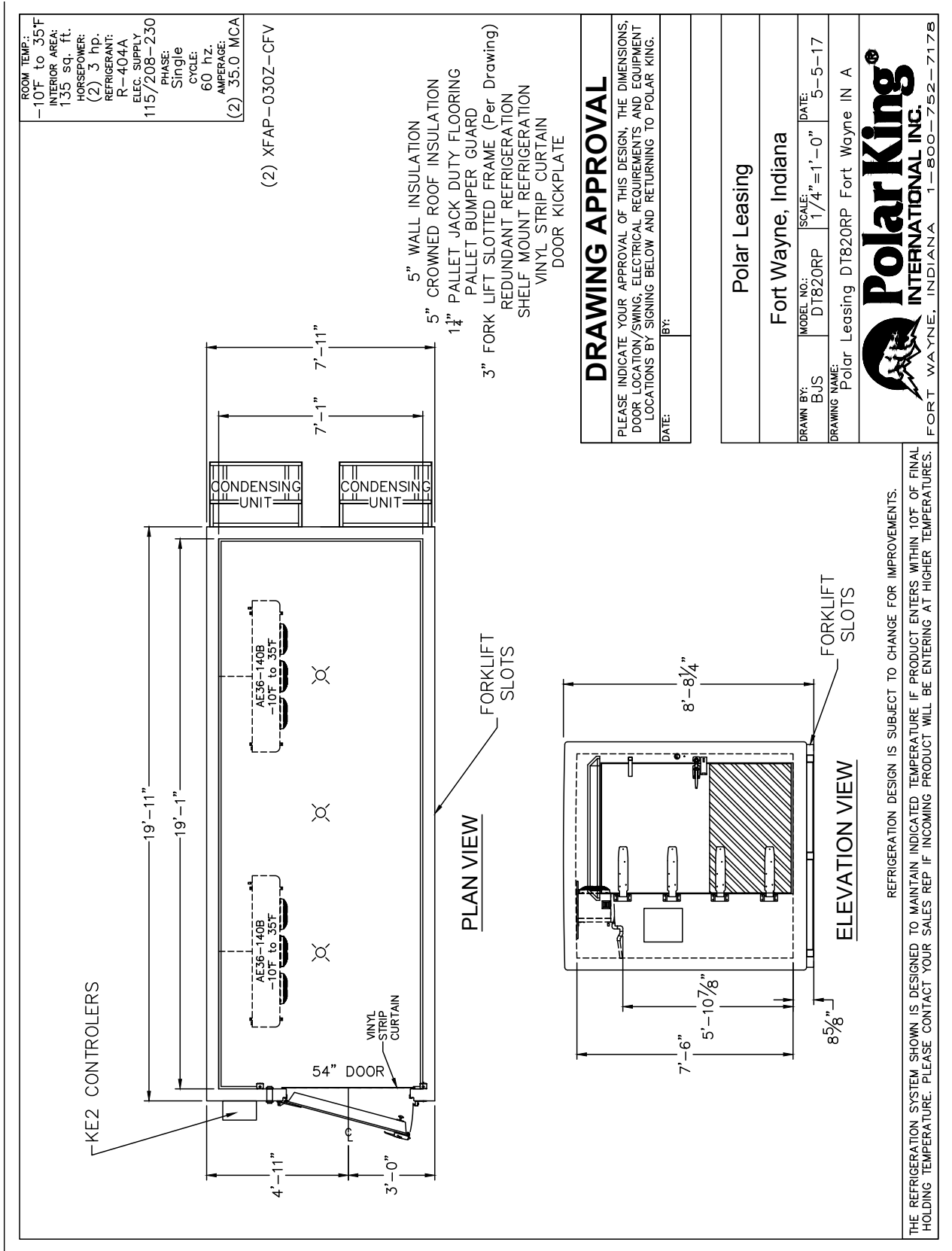



VALIDATION SUMMARY REPORT

Walk-in Refrigeration Storage / Cold Room

Title: Validation Summary Report for Walk-in Refrigeration / Cold Room Model DT820P

Manufacturer:	Polar King International, Inc.
Model Number:	DT820P
Equipment ID / Serial No:	918-8557

Revision Number: 1
Issue Date: 08/09/2018



Manufacturer:	Polar King International, Inc.
Model Number:	DT820P
Equipment ID / Serial No:	918-8557

Table Of Contents

1.0	INTRODUCTION	3
2.0	REFERENCES	3
3.0	SUMMARY	3
3.1	INSTALLATION & QUALIFICATION	3
3.1.1	System Components Identification	3
3.1.2	Documentation Verification	3
3.1.3	Refrigeration System Components Visual Inspection.....	3
3.1.4	Electrical Supply Verification	3
3.1.5	Thermostatic Controller Identification	4
3.1.6	Refrigeration System Spare Parts	4
3.2	OPERATION QUALIFICATION.....	4
3.2.1	Vaisala Validation Equipment Calibration Verification	4
3.2.2	Temperature Data Logger Placement.....	4
3.2.3	24-HR Empty Unit Thermal Mapping (5°C Set Point)	5
3.2.4	Empty Unit Open Door Temperature Recovery (5°C Set Point).....	6
3.2.5	Empty Unit Power Failure Test (5°C Set Point)	7
3.2.6	24-HR Empty Unit Thermal Mapping (-20°C Set Point).....	7
3.2.7	Empty Unit Open Door Temperature Recovery (-20°C Set Point).....	8
3.2.8	Empty Unit Power Failure Test (-20°C Set Point)	8
3.3	Qualification Deviations	8
4.0	CONCLUSION	8
5.0	APPROVALS	9
6.0	Vaisala DL1000-1400 Specifications	10
7.0	Polar Leasing 8x20 Pallet Door Unit Line Drawing	14



Manufacturer:	Polar King International, Inc.
Model Number:	DT820P
Equipment ID / Serial No:	918-8557

1.0 INTRODUCTION

The Validation Summary Report summarizes the qualification activities measured on the Walk-In Cold Room, Polar Leasing Unit 918-8557. The unit is manufactured by Polar King International, Inc. and has a model number of DT820P. It is controlled by a Johnson Controls thermostat model A419 and is equipped with a 54” insulated door and a floor rated for pallet jack duty. This summary also covers any discrepancies encountered throughout the validation study.

2.0 REFERENCES

Temperature mapping of storage area, technical supplement to WHO Technical Report Series, No. 961, 2011.

3.0 SUMMARY

3.1 INSTALLATION & QULAIFICATION

The validation study for 918-8557 was completed on July 10th, 2018. Verifications for the study were documented and saved using Vaisala Veriteq vLog.

3.1.1 System Components Identification

Identification information for the Cold Room was verified. This included model and serial numbers for the condensing unit, compressor, and structure. Refrigerant type and expansion valve were confirmed, as was insulation thickness.

3.1.2 Documentation Verification

Documentation for installation and maintenance of 918-8557 was obtained. These documents were reviewed, and include manuals, CAD drawings, quality control reports and production worksheets.

3.1.3 Refrigeration System Components Visual Inspection

A visual inspection of refrigeration system components was conducted to verify the equipment was installed in accordance with the manufacturer’s recommendation. Critical components were confirmed to be in new working order. No damage was noted.

3.1.4 Electrical Supply Verification

A Fluke Multimeter was used to confirm the provided voltage supply was in accordance with requirements specified on the serial plate of the Cold Room.



Manufacturer:	Polar King International, Inc.
Model Number:	DT820P
Equipment ID / Serial No:	918-8557

3.1.5 Thermostatic Controller Identification

The installation location of one thermostatic control was noted and documented as required. Vaisala temperature data logger #4 was used to log data at thermocouple locations. All set points used for testing were documented as necessary.

3.1.6 Refrigeration System Spare Parts

No spare parts are required for the Validation Summary.

3.2 OPERATION QUALIFICATIONS

3.2.1 Vaisala Validation Equipment Calibration Verification

Calibration documentation for all Vaisala DL1000-1400 was reviewed and all temperature data loggers were found to be in calibration as required.

3.2.2 Temperature Data Logger Placement

The set-up of all temperature monitoring loggers was done in accordance with acceptable usage practices, obtaining measurements at multiple low, medium and high points within the Cold Room. A total of 19 data points were logged in each study, as shown in Figure 1.

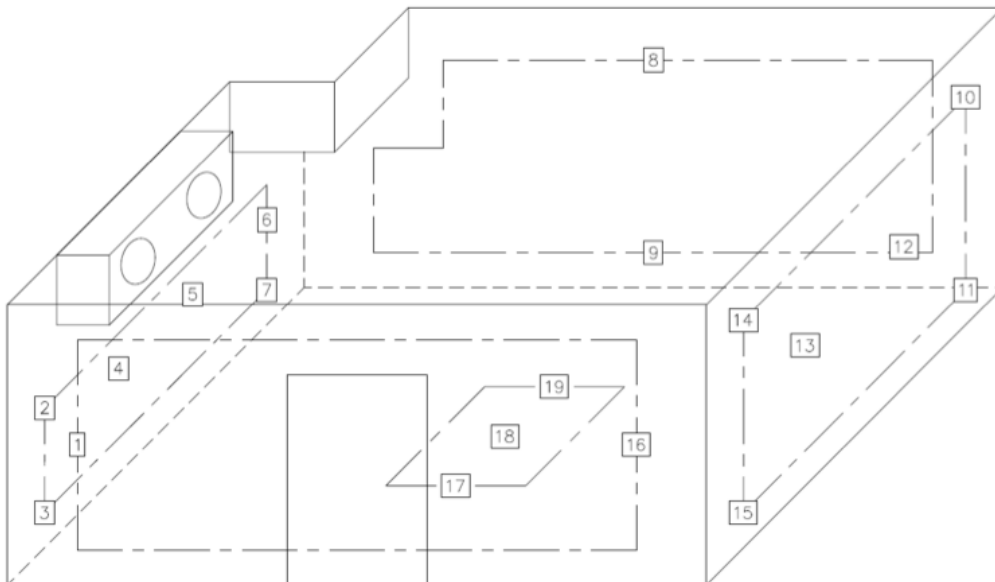

Figure 1



Manufacturer:	Polar King International, Inc.
Model Number:	DT820P
Equipment ID / Serial No:	918-8557

Table 1: Temperature Data Logger Locations and Labels

Data Logger Location	Data Logger Label	Alternate Data Logger Label
1	VA Logger #1	17341013
2	VA Logger #2	17341014
3	VA Logger #3	17381125
5	VA Logger #5	17381127
6	VA Logger #6	17381085
7	VA Logger #7	17381084
8	VA Logger #8	17381124
9	VA Logger #9	17381128
10	VA Logger #10	17381126
11	VA Logger #11	17381086
12	VA Logger #12	17381082
13	VA Logger #13	17371094
14	VA Logger #14	17381121
15	VA Logger #15	17381122
16	VA Logger #16	16451060
17	VA Logger #17	17381123
18	VA Logger #18	17371120
19	VA Logger #19	17371109

3.2.3 24-HR Empty Unit Thermal Mapping (5°C Set Point)

At a set point of 5°C the Cold Room was tested empty, with the door closed. Temperature data loggers were positioned as shown in figure 1. Temperature data was recorded for a 24 hr period, from 12:00pm EDT on 06/23/18 to 12:00pm EDT on 06/24/18. The data was logged at 30 second intervals. No deviations were recorded during testing. The summarized data for all temperature data loggers can be found in Table 2.



Manufacturer:	Polar King International, Inc.
Model Number:	DT820P
Equipment ID / Serial No:	918-8557

Table 2: Temperature Data Logger Locations and Labels

Data Logger Location	Data Logger Label	Data Logger Label (Alternate)	Max Temp (°C)	Avg. Temp (°C)	Min Temp (°C)
1	VA Logger #1	17341013	6.46	5.59	4.38
2	VA Logger #2	17341014	6.44	5.69	4.69
3	VA Logger #3	17381125	6.41	5.47	4.13
5	VA Logger #5	17381127	6.22	5.40	4.28
6	VA Logger #6	17381085	6.09	5.38	4.58
7	VA Logger #7	17381084	6.08	5.43	4.73
8	VA Logger #8	17381124	6.10	5.45	4.68
9	VA Logger #9	17381128	6.05	5.54	5.10
10	VA Logger #10	17381126	6.06	5.41	4.69
11	VA Logger #11	17381086	5.99	5.45	5.04
12	VA Logger #12	17381082	5.95	5.49	5.12
13	VA Logger #13	17371094	6.05	5.21	4.37
14	VA Logger #14	17381121	6.35	5.28	3.63
15	VA Logger #15	17381122	6.49	5.68	4.61
16	VA Logger #16	16451060	6.30	5.64	4.94
17	VA Logger #17	17381123	6.32	5.82	5.35
18	VA Logger #18	17371120	5.89	5.39	4.93
19	VA Logger #19	17371109	5.97	5.50	5.11

3.2.4 Empty Unit Open Door Temperature Recovery (5°C Set Point)

The test was conducted between 09:05am EDT and 9:50am EDT on 06/26/18. After 25 minutes, only two temperature data loggers showed temperatures outside of specification, while test criteria required at least 50% of data loggers to do so. The test was terminated after 25 minutes, as door openings of this length are well outside of the scope of use. The graphical and detailed report of internal and external data loggers is appended.



Manufacturer:	Polar King International, Inc.
Model Number:	DT820P
Equipment ID / Serial No:	918-8557

3.2.5 Empty Unit Power Failure Test (5°C Set Point)

The test was conducted between 11:21am EDT and 02:15pm EDT on 07/02/18. Temperature was logged at 30 second intervals. The logged data showed the empty Cold Room, with the power supply disconnected; held temperature within the acceptable range for 1 hour and 29 minutes when exposed to an average ambient temperature of 22.9°C. With restored power, the unit stabilized within the acceptable range in approximately 4 minutes. The graphical report and data logs are appended.

3.2.6 24-HR Empty Unit Thermal Mapping (-20°C Set Point)

At a set point of -20°C the Cold Room was tested empty, with the door closed. Temperature data loggers were positioned as shown in figure 1. Temperature data was recorded for a 24 hr period, from 10:00am EDT on 07/05/18 to 10:00am EDT on 07/06/18. The data was logged at 30-second intervals. Individual graph and data reports, as well as a summary data report have been included as appendices. The summarized data for all temperature data loggers can be found in Table 3. No deviations were found.

Table 3: Temperature Data Logger Locations and Labels

Data Logger Location	Data Logger Label	Alternate Data Logger Label	Max Temp (°C)	Avg. Temp (°C)	Min Temp (°C)
1	VA Logger #1	17341013	-14.57	-20.24	-21.33
2	VA Logger #2	17341014	-13.32	-20.01	-21.19
3	VA Logger #3	17381125	-14.39	-20.40	-21.64
5	VA Logger #5	17381127	-14.63	-20.50	-21.62
6	VA Logger #6	17381085	-15.37	-20.45	-21.31
7	VA Logger #7	17381084	-15.80	-20.34	-21.06
8	VA Logger #8	17381124	-15.45	-20.29	-21.10
9	VA Logger #9	17381128	-13.19	-19.79	-20.59
10	VA Logger #10	17381126	-15.60	-20.36	-21.19
11	VA Logger #11	17381086	-14.79	-20.14	-20.77
12	VA Logger #12	17381082	-15.94	-20.13	-20.73
13	VA Logger #13	17371094	-14.89	-20.81	-21.64
14	VA Logger #14	17381121	-13.93	-20.88	-22.33
15	VA Logger #15	17381122	-12.00	-20.16	-21.52
16	VA Logger #16	16451060	-15.15	-20.05	-20.92
17	VA Logger #17	17381123	-15.23	-19.43	-20.11
18	VA Logger #18	17371120	-15.95	-20.38	-20.99
19	VA Logger #19	17371109	-15.90	-20.41	-21.10



Title: Validation Summary Report for Walk-in Refrigeration / Cold Room Model DT820P

Manufacturer:	Polar King International, Inc.
Model Number:	DT820P
Equipment ID / Serial No:	918-8557

3.2.7 Empty Unit Open Door Temperature Recovery (-20°C Set Point)

The test was conducted between 11:02am EDT and 12:02pm EDT on 07/09/18. After 25 minutes, only 5 data loggers showed temperatures outside of specification, while test criteria required at least 50% of data loggers to do so. The test was terminated, as door openings of this length are well outside of the scope of use. The graphical and detailed report of internal and external data loggers is appended.

3.2.8 Empty Unit Power Failure Test (5°C Set Point)

The test was conducted between 11:54am EDT and 03:30pm EDT on 07/10/18. Temperature was logged at 30-second intervals. The logged data showed the empty Cold Room, with the power supply disconnected, held temperature within the acceptable range for approximately 2 hours and 30 minutes when exposed to an average ambient temperature of 25.3°C. With restored power, the unit stabilized within the acceptable range in approximately 8 minutes. The graphical report and data logs are appended.

3.3 Qualification Deviations

No deviations were found during testing.

4.0 CONCLUSION

Temperature validation of #918-8557 was deemed a success without any deviations to report.



Title: Validation Summary Report for Walk-in Refrigeration / Cold Room Model DT820P

Manufacturer:	Polar King International, Inc.
Model Number:	DT820P
Equipment ID / Serial No:	918-8557

5.0 Approvals

In review of the collected data for this Validation Summary Report, this study has been deemed successfully completed with satisfactory results. All deviations are listed within the Validation Summary report and are available by request as appendices. The Polar Leasing unit #918-8557 has been successfully validated.

Name: David C Schenkel Signature: 

Title: President Date: 8/10/18

Name: Todd Ellinger Signature: 

Title: VP Business Admin Date: 8-10-18

Polar Leasing Company Approvals:

The signatures below indicate a full review and understanding of the validation data, thus fully completing the requirements of the report.

Name: Bart Tippmann Signature: 

Title: President Date: 8-10-18

Name: _____ Signature: _____

Title: _____ Date: _____

Manufacturer:	Polar King International, Inc.
Model Number:	DT820P
Equipment ID / Serial No:	918-8557

VAISALA

www.vaisala.com

Vaisala DL1000-1400 Temperature Data Logger



The 1000/1400 temperature data loggers include the VL-series for regulated environments and the SP-series for non FDA/GxP regulated industries. The VL-series of data loggers, together with vLog VL software, provide a superior, high accuracy solution for use in FDA/GxP regulated environments by ensuring tamperproof files and electronic records that meet 21 CFR Part 11 requirements. The SP-series provides a compact, easily deployable, highly

accurate measurement and recording device. Coupled with vLog SP software for downloading, displaying, analyzing and reporting of recorded environmental data, the SP-series was designed for use in non FDA/GxP regulated environments. Optional browser-based viewLinc software provides 24/7 multi-stage alarm notification and remote monitoring for both the VL and SP series of data loggers.

Features/Benefits

- Industry-leading precision and accuracy
- Printed reports for any time period
- 10-year battery
- Validation and continuous monitoring with the same model
- Two year limited warranty
- Superior alternative to chart recorders and hard-wired systems
- Traceable to SI units through national metrology institutes.*
- Timebase calibrated over the operating temperature range
- Adjustable time based recording
- Snap-in logger cradle for easy network connectivity
- Two probe options give high accuracy - from -90 °C to +70 °C

* Measurement results are traceable to the international system of units (SI) through national metrology institutes (NIST USA, MIKES Finland, or equivalent) or ISO/IEC 17025 accredited calibration laboratories.

Applications

Ideal for Monitoring & Validation of:

- Refrigerators & Freezers (to -90 °C)
- Incubators
- Stability Chambers
- Warehouses
- Ambient conditions



Manufacturer:	Polar King International, Inc.
Model Number:	DT820P
Equipment ID / Serial No:	918-8557

Technical Data

General

Size	85 x 59 x 26 mm (3.4 x 2.3 x 1") 76 g (2.7oz)
Interfaces	RS-232 serial, USB, Ethernet, WiFi, PoE network interface available
Mounting	3M Dual Lock™ Fasteners Snap-in connector locks provide secure probe connections
PC Software	Graphing & Reporting Software vLog SP for SP-series vLog VL for VL-series viewLinc for continuous monitoring & alarming OPC Server to add on to existing OPC compatible monitoring systems
Internal Clock	Accuracy ±1 min. /month -25 °C to +70 °C (-13 °F to +158 °F)
Electromagnetic Compatibility	FCC Part 15 and CE
Power Source	Internal 10-year lithium battery (Battery life specified with sample interval of 1 min. or longer)
Logger Operating/Storage Range	-40 °C to +85 °C (-40 °F to +185 °F) 0 %RH to 100 %RH non-condensing

Internal Temperature Sensor

Series	Sensor Type
1000-21x	Precision-tolerance epoxy-encapsulated NTC thermistor

Memory

Data Sample Capacity	
1000-2XX	48,100 12-bit samples
1400-44X	85,300 12-bit samples
Memory Type	Non-volatile EEPROM
Memory Modes	User selectable: wrap (FIFO) or stop when memory is full. User selectable start time. User selectable stop time (VL series only).
Sampling Rates	User-selectable (in 10 second intervals) from once every 10 seconds to once a day.

Recording Span: 1000-2xx

SAMPLE INTERVAL	NUMBER OF CHANNELS ENABLED	
	1	2
10 Seconds	5.5 Days	2.7 Days
1 Minute	1.1 Months	16.7 Days
5 Minutes	5.5 Months	2.7 Months
15 Minutes	1.3 Years	8.3 Months
1 Hour	5.4 Years	2.7 Years



VL-1000-21x



VL-1000-22x

Recording Span: 1400-44x

SAMPLE INTERVAL	NUMBER OF CHANNELS ENABLED			
	1	2	3	4
10 Seconds	9.8 Days	4.9 Days	3.2 Days	2.4 Days
1 Minute	1.9 Months	29.6 Days	19.7 Days	14.8 Days
5 Minutes	9.8 Months	4.9 Months	3.2 Months	2.4 Months
15 Minutes	2.4 Years	1.2 Years	9.8 Months	7.4 Months
1 Hour	9.7 Years	4.8 Years	3.2 Years	2.4 Years



VL-1400-44x



Manufacturer:	Polar King International, Inc.
Model Number:	DT820P
Equipment ID / Serial No:	918-8557

EPT Series Temperature Probes

Sensor Models

"N" Range External Probes	EPT-23N-XXN and EPT-22W-XXN
Operating/Storage Range	-40 °C to +95 °C (-40 °F to +203 °F)
Connector Color Code	Black
"V" Range External Probes	EPT-23N-XXV and EPT-22W-XXV
Operating/Storage Range	-95 °C to +95 °C (-139 °F to +203 °F)
Connector Color Code	Blue

EPT - XXX - XXX

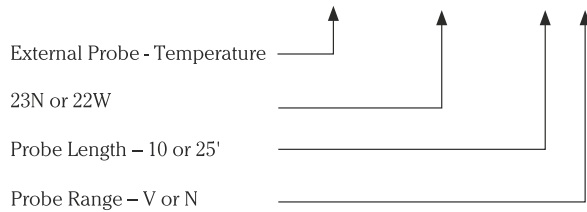

Sensor Tips

EPT-23N-XXX	Stainless Steel Diameter 3.2 mm (1/8") °F Length 38 mm (1.5")
EPT-22W-XXX (liquid submersible)	Sealed Teflon Tip Diameter 3 mm (0.12") Length 28 mm (1.1")
Probe Lengths	3 m (10') and 7.6 m (25')
Cable Construction	2mm (0.07") Diameter Teflon coated cable

Temperature Probe Accessories

Thermal Dampening Block, for use in refrigerators and freezers, simulates a glycol bottle to reduce viewLinc alarms generated by opening and closing a door.





Manufacturer:	Polar King International, Inc.
Model Number:	DT820P
Equipment ID / Serial No:	918-8557

Product Part Number Legend: Guide for reading the product tables and selecting the most appropriate model for your application.

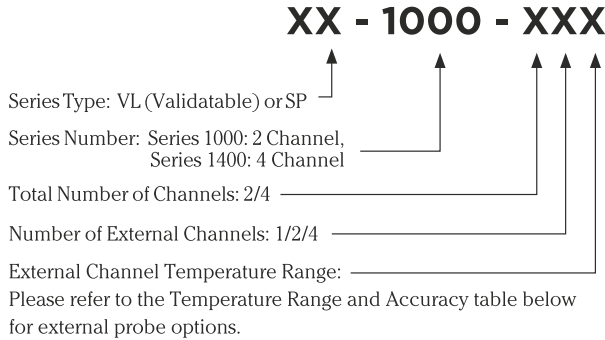

Temperature Range and Accuracy

Internal Sensor

Calibrated	
Measurement Range	-25 °C to +70 °C (-13 °F to +158 °F)
Operating/Storage Range	-40 °C to +85 °C (-40 °F to +185 °F)
0 %RH to 100 %RH non-condensing	
Initial Accuracy	+/-0.10 °C over +20 °C to +30 °C (+/-0.18 °F over +68 °F to +86 °F) +/- 0.2 °C over -25 °C to +70 °C (+/- 0.36 °F over -13 °F to +158 °F)
One Year Accuracy	+/-0.15 °C over +20 °C to +30 °C (+/-0.27 °F over +68 °F to +86 °F) +/-0.25 °C over -25 °C to +70 °C (+/-0.45 °F over -13 °F to +158 °F)
Resolution	0.02 °C at +25 °C (0.04 °F at +77 °F)

External Probes - All Models

"N" RANGE EXTERNAL PROBE	
Calibrated	
Measurement Range	-25 °C to +70 °C (-13 °F to +158 °F)
Operating/Storage Range	-40 °C to +95 °C (-40 °F to +203 °F)
Initial Accuracy*	+/-0.10 °C over +20 °C to +30 °C (+/-0.18 °F over +68 °F to +86 °F) +/-0.15 °C over -25 °C to +70 °C (+/-0.27 °F over -13 °F to +158 °F)
One Year Accuracy*	+/-0.2 °C over +20 °C to +30 °C (+/-0.36 °F over +68 °F to +86 °F) +/-0.25 °C over -25 °C to +70 °C (+/-0.45 °F over -13 °F to +158 °F)
Resolution	0.02 °C at +25 °C (0.04 °F at +77 °F)
"V" RANGE EXTERNAL PROBE	
Calibrated	
Measurement Range	-90 °C to -40 °C (-130 °F to -40 °F)
Operating/Storage Range	-95 °C to +95 °C (-139 °F to +203 °F)
Initial Accuracy*	+/- 0.2 °C over -90 °C to -40 °C (+/- 0.36 °F over -130 °F to -40 °F)
One Year Accuracy*	+/-0.25 °C over -90 °C to -40 °C (+/-0.45 °F over -130 °F to -40 °F)
Resolution	0.02 °C at -80 °C (0.04 °F at -112 °F)

*Specification for external channels is for a probe calibrated to the specific channel of the data logger and with the data logger at -25 °C to +70 °C (-13 °F to +158 °F)



www.vaisala.com

Please contact us at www.vaisala.com/requestinfo



Scan the code for more information

Ref. B211044EN-D ©Vaisala 2017
This material is subject to copyright protection, with all copyrights retained by Vaisala and its individual partners. All rights reserved. Any logos and/or product names are trademarks of Vaisala or its individual partners. The reproduction, transfer, distribution or storage of information contained in this brochure in any form without the prior written consent of Vaisala is strictly prohibited. All specifications — technical included — are subject to change without notice.





Manufacturer:	Polar King International, Inc.
Model Number:	DT820P
Equipment ID / Serial No:	918-8557

ROOM TEMP.:
-10F to 35F
INTERIOR AREA:
140 sq. ft.
INTERIOR VOLUME:
1018 cu. ft.
HORSEPOWER:
2.25 hp.
REFRIGERANT:
R-404A
ELEC. SUPPLY:
115/208-230
PHASE:
Single
CYCLE:
60 hz.
AMPERAGE:
27.1 MCA

3" FORK LIFT FRAME
PALLET DOOR

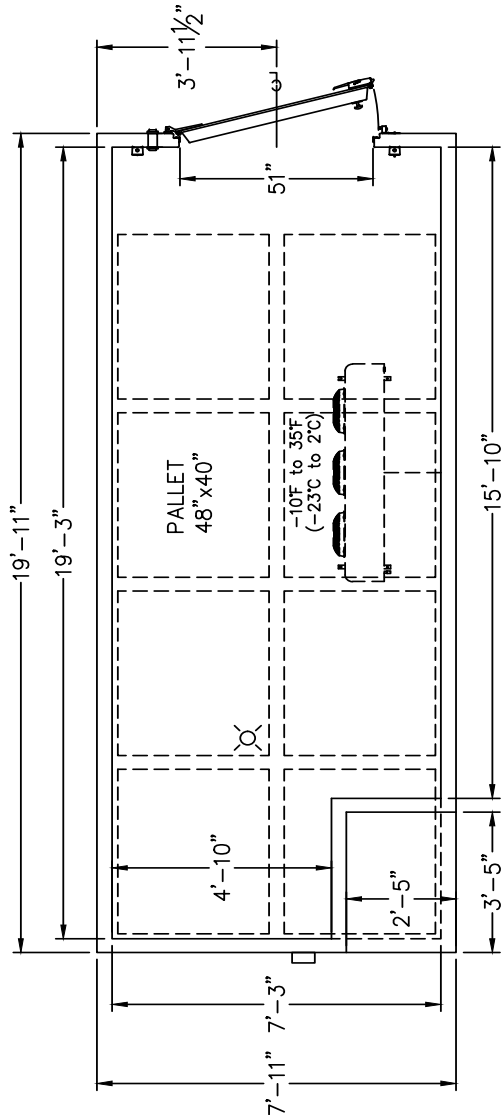

PLAN VIEW

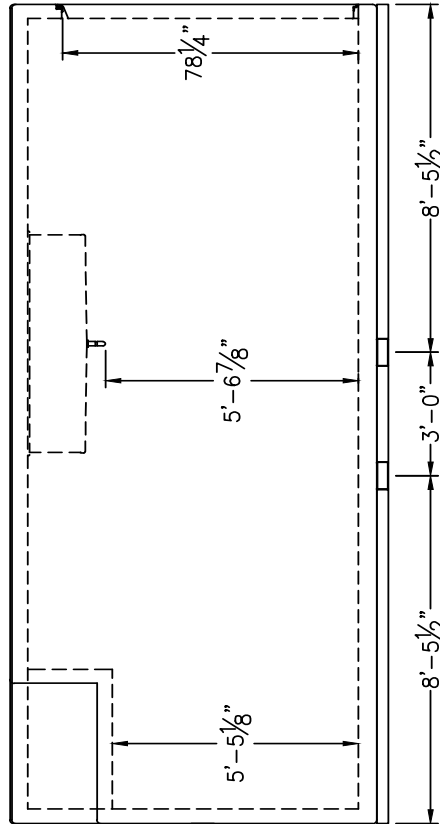

ELEVATION VIEW

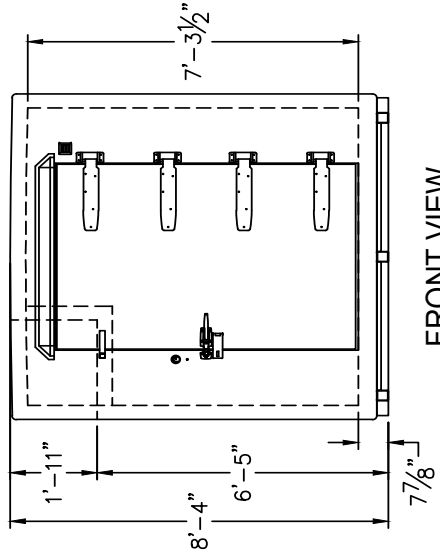

FRONT VIEW

DRAWN BY: BJS	MODEL NO.: DT820	SCALE: 1/4" = 1'-0"	DATE: 10-14-16
DRAWING NAME: Low Profile DT820 Pallet			



THE REFRIGERATION SYSTEM SHOWN IS DESIGNED TO MAINTAIN INDICATED TEMPERATURE IF PRODUCT ENTERS WITHIN 10F OF FINAL HOLDING TEMPERATURE. PLEASE CONTACT YOUR SALES REP IF INCOMING PRODUCT WILL BE ENTERING AT HIGHER TEMPERATURES.